

Shatterstone

A Four-Round Dungeons & Dragons® Living Greyhawk™ Core Adventure

Version 1

by Creighton Broadhurst, Jean-Philippe "JP" Chapleau, R. Michael Hinds, and Colleen Simpson

Circle Reviewer: Creighton Broadhurst

HQ Reviewer: Chris Tulach

Playtesters: Tena DeVoll, John Foye, Pam Foye, Leonard Logan and Murry McEntire

Rumors of cults once again stalking the underside of the free city and the discovery of a long-thought destroyed dungeon level under the War Tpwcr call once again for brave (or foolhardy) adventurers to investigate. The final part of "Greyhawk Ruins". A three-round core adventure for characters level 1-11 (APLs 2-8) set in the Domain of Greyhawk.

Resources for this adventure [and the authors of those works] include *City of Peril* [Ed Stark], *Complete Arcane* [Richard Baker], *Dungeon Master's Guide II* [Jesse Decker, David Noonan, Chris Thomasson, James Jacobs, and Robin D. Laws], *Dungeonscape* [Jason Bulmahn and Rich Burlew], *Expedition to the Ruins of Greyhawk* [Jason Bulmahn, James Jacobs, Erik Mona], *Greyhawk Ruins* [Blake Mobley, Timothy B. Brown], *Greyhawk Ruins Sourcebook* [Creighton Broadhurst, Chris Chesher, Paul Looby, Bruce Paris, and Sam Weiss], *Libris Mortis* [Andy Collins, Bruce R. Cordell], *Magic Item Compendium* [Andy Collins, Eytan Bernstein, Frank Brunner, Owen K.C. Stephens, John Snead], *Monster Manual III* [Rich Burlew, Eric Cagle, Jesse Decker, Andrew J Finch, Gwendolyn F.M. Kestrel, Rich Redman, Matthew Sernett, Chris Thomasson, P Nathan Toomey], *Monster Manual IV* [Gwendolyn F. M. Kestrel, Jennifer Clarke Wilkes, Matthew Sernett, Eric Cagle, Andrew Finch, Christopher Lindsay, Kolja Raven Liquelette, Chris Sims, Owen K. C. Stephens, Travis Stout, JD Wiker, Skip Williams], *Monster Manual V* [Creighton Broadhurst, Jason Bulmahn, David Chart, B. Matthew Conklin III, Jesse Decker, James "Grim" Desborough, Rob Heinsoo, Sterling Hershey, Tim Hitchcock, Luke Johnson, Nicolas Logue, Mike McArtor, Aaron Rosenberg, Robert J. Schwalb, Rodney Thompson, Wil Upchurch], *Player's Handbook II* [David Noonan], and *Races of the Dragon* [Gwendolyn F. M. Kestrel, Jennifer Clarke Wilkes, Kolja Raven Liquelette], *Spell Compendium* [Matthew Sernett, Jeff Grubb, Mike McArtor], and *The Adventure Begins* [Roger E. Moore].

Based on the original Dungeons & Dragons® rules created by E. Gary Gygax and Dave Arneson and the new Dungeons & Dragons game designed by Jonathan Tweet, Monte Cook, Skip Williams, Richard Baker, and Peter Adkison.

This game product contains no Open Game Content. No portion of this work may be reproduced in any form without permission of Wizards of the Coast. To learn more about the Open Gaming License and the d20 System license, please visit www.wizards.com/d20

This is an official RPGA® play document. To find out more about the RPGA and to learn more on how you can sanction and run Dungeons & Dragons game events of all sizes, visit our website at www.rpga.com.

DUNGEONS & DRAGONS, D&D, GREYHAWK, Living Greyhawk, D&D Rewards, RPGA, Player's Handbook, Dungeon Master's Guide, and Monster Manual are trademarks of Wizards of the Coast, Inc, in the US and other countries. This material is protected under the copyright laws of the United States of America. Any reproduction or unauthorized use of the material or artwork contained herein is prohibited without the express written permission of Wizards of the Coast, Inc. This product is a work of fiction. Any similarity to actual people, organizations, places, or events is purely coincidental. © 2008 Wizards of the Coast, Inc.

Visit the Living Greyhawk website at www.rpga.com.

RPGA® SANCTIONED PLAY

Most likely you ordered this adventure as part of an RPGA event from the RPGA website, or you received it from your senior gamemaster. To play this adventure as part of the Living Greyhawk campaign—a worldwide, ongoing D&D® campaign set in the Greyhawk setting—you must sanction it as part of an RPGA event. This event could be as elaborate as a big convention, or as simple as a group of friends meeting at the DM's house.

To sanction an RPGA event, you must be at least a Herald-Level™ gamemaster. The person who sanctions the event is called the senior gamemaster, and is in charge of making sure the event is sanctioned before play, runs smoothly on the date sanctioned, and then reported back to the RPGA in a timely manner. The person who runs the game is called the session Dungeon Master (or usually just DM). Sometimes (and almost all the time in the cases of home events) the senior gamemaster is also the session DM. You must be at least a Herald-Level GM to run this adventure.

By sanctioning and reporting this adventure, you accomplish a couple of things. First, it is an official game, and you can use the AR to advance your Living Greyhawk character. Second, players and DMs gain rewards for sanctioned RPGA play if they are members of the Dungeons & Dragons Rewards program. Playing this adventure is worth two (2) points.

This adventure retires from RPGA-sanctioned play on December 31, 2008.

To learn more about the Living Greyhawk character creation and development, RPGA event sanctioning, and Dungeons & Dragons Rewards, visit the RPGA website at www.rpga.com.

PLAYERS READ NO FARTHER

If you are planning on playing this adventure, stop reading now. The rest of the information in this adventure is for the DM only. If you read farther than this section, you'll know too much about its challenges, which kills the fun. Also, if you're playing this adventure as part of an RPGA-sanctioned event, reading beyond this point makes you ineligible to do so.

PREPARING FOR PLAY

To get the most out of this adventure, you need copies of the following D&D rule books: *Player's Handbook*, *Dungeon Master's Guide*, and the *Monster Manual*.

Core adventures often utilize new rules items – including new classes, prestige classes, races, feats, spells, and equipment (including magic items) – that do not appear in any of the three core D&D books (*Player's Handbook*, *Dungeon Master's Guide*, or *Monster Manual*). The full write-up of any featured feats, spells, or equipment appears in Appendix 2. Information on featured classes, prestige classes, and races appears in the relevant creature's stat block. This adventure includes all the information required to run these characters. The DM

should double-check that he fully understands any new rule items presented in this adventure before play begins.

Along with this adventure, you'll find a RPGA session tracking sheet. If you're playing this adventure as part of an RPGA-sanctioned event, complete and turn in this sheet to your senior GM directly after play. You'll also find a Living Greyhawk adventure record (AR). You need one copy of this for each participating player.

LAYOUT AND ORGANIZATION

This adventure has several sections:

- **CGR8-02:1 A Short Way with Little Knowledge:** Travelers waylaid, caravans attacked, no survivors, all in the plain of Greyhawk. Someone thinks he knows who is responsible and he plans on doing something about it. It is a short way with little knowledge. This adventure is a loose sequel to COR6-04 *A Long way for a little knowledge*.
- **CGR8-02:2 Greyhawk City Puzzle:** What do the deaths of a wizard's daughter and a priestess's favored servant have to do with an invitation to the Foreign Quarter? Once again, the City of Greyhawk is host to yet another deadly puzzle and you've been drawn right into the middle. Can you find the connection? This is an investigation that still has some use for fighters.
- **CGR8-02:3 Little Things:** Come see the treasures from the ruins of Greyhawk! Come see the magical mirrors, the ornate carvings, the beautiful statues. Come see the tapestry drag one of our patrons into itself... Now hold it right there – that wasn't something you expected. Are you just going to stand there? Or are you going to go to the rescue?
- **Appendices:** This section contains all the New Rules Items required for this adventure as well as affiliation briefing sheets and any other required generic information.

LIVING GREYHAWK LEVELS OF PLAY

Because players bring their own characters to Living Greyhawk games, this adventure's challenges are proportionate to the modified average character level of the PCs participating in the adventure. To calculate the Average Party Level (APL), follow the process below:

1. Determine the character level for each of the PCs participating in the adventure. Each PC may bring one animal, plus any creatures gained from class abilities to help in combat. (PCs can bring more creatures but they cannot help in combat). If you deem that the animal bestows a significant benefit in combat add the animal's CR to the level of the PC it is accompanying for calculating APL. (Animals gained from class abilities and one standard horse, warhorse, or riding dog for a PC with Mounted Combat do not affect APL).

2. Sum the results of step 1 and divide by the number of characters playing in the adventure. Round to the nearest whole number.
3. If you are running a table of six PCs, add one to that average.

Throughout this adventure, APLs categorize the level of challenge the PCs face. APLs are given in even-numbered increments. If the APL of your group falls on an odd number, ask them before the adventure begins whether they would like to play a harder or easier adventure. Based on their choice, use either the higher or the lower adjacent APL.

APL also affects the amount of experience and gold a PC can gain at the end of the adventure. A player character more than three levels higher than the APL at which the adventure is played cannot participate. If a player character is more than two levels away from the APL at which the adventure is played, he suffers a 50% penalty to the amount of gold and XP gained in the adventure. This simulates the fact that either the PC was not challenged as much as normal or relied on help by higher-level characters to reach the objectives.

Living Greyhawk adventures are designed for APL 2 and higher. Four or five 1st-level characters may find the challenge of an APL 2 adventure difficult. Suggest the following to these groups to help increase their chances of success:

1. Enlist a sixth player.
2. Advise characters to buy riding dogs to help protect them and fight for them.

These APL calculation rules reference version 7.0 of the *Living Greyhawk Campaign Sourcebook*. If you are playing this adventure in 2008, check the current version of the LGCS and follow any updated rules presented within.

TIME UNITS AND UPKEEP

This is a “Greyhawk Ruins” adventure. Each “Greyhawk Ruins” adventure comprises three distinct rounds (or zones), set in the Domain of Greyhawk. Treat each adventure as a separate round. Thus, it costs most characters 2 TUs to participate in each round but characters with the Domain of Greyhawk as their home region pay only 1 TU per round. Characters must pay upkeep for each round in which they participate.

Each round has its own AR. A character receives an AR for a round at the end of the session in which he first earns XP or gp from that particular part of the dungeon. Once a character has received an AR for a zone, he may never again adventure in that area.

A character can chose to explore all the rounds of this adventure in a single (mega) session (equivalent to four adventure rounds) or can chose to enter them one at a

time (taking up to four sessions to complete the entire adventure).

Adventurer’s Standard Upkeep costs 12 gp per time unit. Rich Upkeep costs 50 gp per time unit. Luxury Upkeep costs 100 gp per time unit. Characters that fail to pay at least Standard Upkeep retain temporary ability damage until the next adventure, must buy new spell component pouches and healer’s kits, and may suffer other in-game penalties (or possibly gain in-game benefits) as may be detailed in this adventure.

A character that does not pay for at least Standard Upkeep may avoid the above-described penalties by living off the wild. If the character possesses four or more ranks in Survival and succeeds on a DC 20 Survival check, he heals temporary ability damage as if he had Standard Upkeep, may refill spell component pouches and healer’s kits, and may restock up to 20 arrows or bolts if the character has at least four ranks in Craft (bowmaking). PCs may Take 10 on this roll.

Chapters 1 and 5 of the LGCS present more information about lifestyle and upkeep.

PREPARATION FOR PLAY

Read these notes before play begins.

GREYHAWK RUINS SOURCEBOOK

To play this adventure you also need a copy of the *Greyhawk Ruins Sourcebook*. The sourcebook contains information about the free city, its laws, and statistics for watchmen, and the like. Download the map free from www.wizards.com/default.asp?x=lg/welcome. The DM should ensure that he reviews the city’s laws before play.

AFFILIATION BRIEFING SHEETS

Many of the PCs participating in this adventure will be members of one of the free city’s affiliations (as detailed in the *Greyhawk Ruins Sourcebook*). Before play begins, hand out the relevant briefing sheet to each player. PCs not belonging to any affiliation must determine for themselves exactly why they are exploring the ruins.

ORDER OF PLAY

Unlike previous parts of “Greyhawk Ruins,” the PCs do not necessarily have to play zone one of this adventure first. Of the four component zones, one takes place in the free city itself while the other three are set below the War Tower. Of these three zones, two – zones one and two – can be accessed from the level above and, thus, can be played first. Both zones link to zone three. When the PCs first enter the dungeons give them the choice of accessing either zone.

ADVENTURE BACKGROUND

Momentous events again threaten to overwhelm the free city of Greyhawk. To the south, Turrosh Mak demands peace with the Domain while bandits grow emboldened by Greyhawk's stretched armed forces. Indeed, some of these bandits have powerful friends within the free city who manipulate the bandits for their own ends.

The rise of banditry has not gone unnoticed in the free city. Many within the city grow concerned at the increase of lawlessness in the Near Domain. Chief among these is Eritai Kaan-Ipzirel, Matriarch of St. Cuthbert. Several months ago, she dispatched Korenth Mauk, a trusted servant, to learn more.

Korenth's investigations quickly bore fruit and he swiftly came to the conclusion that the ruins of the infamous Castle Greyhawk – only a few miles from the city – was in some way connected to the rise of lawlessness in the Domain. Unfortunately, his investigations drew the attention of certain powerful individuals who were angered at Eritai's servant poking his nose into such sensitive matters. Thus, Korenth was slain by a master assassin two days ago. Korenth resisted mightily, however, and the sound of battle alerted those staying in the nearby rooms, so the assassin could not complete a thorough search of the room, leaving vital evidence unrecovered.

In CGR7-01 *Ruins of Discovery*, the PCs uncovered clues within Korenth's room confirming that his investigations centered on the ruins of Castle Greyhawk. Setting out to the ruins, bandits beset the PCs but were eventually slain. Once they reached the ruins, they entered the War Tower after bargaining with the Wartower Wardens. Exploring the dungeons, they destroyed many foul creatures and odious individuals and discovered that the bandits were in some way using portions of the first level (and perhaps areas below) that as a kind of base of operations.

In CGR7-02 *The Silent Barracks* the adventurers again returned to the dungeons below the War Tower and fought many dangerous creatures and defeated several fiendish traps during their exploration of the second dungeon level. They also discovered another nest of bandits but their exploration of the bandits' base was complicated by an invasion of undead that had recently ascended from a lower level. While the undead and the bandits were eventually defeated, the PCs uncovered no definitive proof of for whom the bandits worked for. To uncover this important information, they are once again called upon to explore the dungeons below Castle Greyhawk.

In CGR8-01 *Crypts of the Forgotten*, the PCs defeated devotees of the demon lord Orcus, explored the halls of a former shrine and defeated the terrifying monsters therein, and added a small band of shapeshifters tighting the machinations of a deadly cult.

Now, the ruins of Castle Greyhawk and the machinations of several bands of evil folk call the PCs back to the free city and the nearby ruins.

INTRODUCTION

As the adventure opens, the PCs are in Greyhawk City. They could be at the Griffon's Nest or at another hostelry. Each of the PCs has been contacted by his affiliation and asked to continue his investigation of the dungeons below the War Tower (refer to the Affiliation Briefing Sheets for more information).

Before play begins, hand out the affiliation briefing sheets to the appropriate PCs and allow them time to assimilate and discuss the included information. PCs without any affiliation score or whose affiliation does not require their services in a particular adventure must decide why they want to explore Castle Greyhawk; likely, the lure of fame and wealth has proved too strong to resist!

The mood of the free city has darkened in recent days. Bandits still stalk the roads and byways of the domain and rumors of cults once again active in the city serve to increase the anxiety of the citizenry and those in power alike. Rampant speculation regarding the true purpose behind Turrosh Mak's recent offer of peace further serves to divide public opinion. Many folk believe that these events are all somehow linked while others dismiss this as little more than paranoia. Whatever the truth of the matter, you have gathered again to pursue the truth wherever it may lie.

Once the PCs have introduced themselves, proceed with the adventure. Remember, that some of the adventures take place in the city, while the other takes place in the ruins themselves.

- **CGR8-02:1 A Short Way with Little Knowledge** takes place in the ruins of Castle Greyhawk.
- **CGR8-02:2 Greyhawk City Puzzle** takes place in the free city.
- **CGR8-02:3 Little Things** takes place in the free city.
- **CGR8-02:2 The Tomb of Pelor** takes place in the ruins of Castle Greyhawk.

It does not matter in which order the PCs wish to complete their tasks.

If the PCs wish to learn more about the castle or recent events, proceed to Encounter One. Before their adventure begins, the PCs have enough time to buy consumable magic items, visit old friends, call in favors, and so on.

If the PCs are playing CGR8-02:1 and want to role-play the journey to the castle, use Encounter Two. Once they arrive at the ruins, use Encounter Three.

1: LEARNING MORE

Doubtless, at some point during the adventure, the PCs will seek to learn more about Castle Greyhawk and other things of interest. When they do so, consult the tables below to determine exactly what they learn.

Characters with ranks in Knowledge (local: core) or bardic knowledge can learn more Castle Greyhawk and its environs. When a character makes a successful skill check, the following lore is revealed, including the information from lower DCs.

GETTING THERE

- **DC 10:** Castle Greyhawk stands eight miles from the city beyond the mighty Selintan. The safest and quickest way to reach it is to follow Marsh Path across Zagig's Bridge.
- **DC 15:** Most people avoid Zagig's Bridge – some say it is haunted or cursed. Several hovels have grown up around the span, mainly populated by landless immigrants from the Wild Coast.

CASTLE GREYHAWK

- **DC 10:** The shattered stumps of the castle's three great towers are clearly visible from North Hills Park. There are rumored to be at least 10 levels of dungeon below each tower as well as strange portals to other planes. The castle was abandoned in 421 CY after Zagig disappeared. Only adventurers explore the ruins now.
- **DC 15:** The three towers are known as the Tower of War (to the east), the Tower of Power (to the west), and the Tower of Magic (in the centre).
- **DC 20:** Returning in secret, Zagig captured nine demigods in the dungeons below his castle around the turn of the century and used their power to propel himself to godhood.

RECENT EVENTS

PCs succeeding on a Gather Information check reveal the relevant information listed below. A success also reveals all information gained by a lesser result.

- **DC 10:** A friend of a friend was coming home late from a tavern a few nights before when he saw a huge spider, easily the size of a horse, scaling a wall near the courthouse! It saw him but didn't attack, disappearing over the rooftops!
- **DC 15:** Many adventurers have been exploring the ruins below Castle Greyhawk. Those returning from below the War Tower tell of desperate battles against hordes of undead and even worse!
- **DC 20:** Turrosh Mak seeks alliance with the free city and has even promised troops to aid our defense. No sane person would agree to such a suggestion. From what I hear, occasional raiding still takes place through the buffer zone. Turin Deathstalker disappeared from Safeton recently for several weeks.

He returned in unusually high spirits. (A DC knowledge [local – core] reveals that the Deathstalker often goes on one-man missions into the Pomarj; whole tribes have fallen beneath his blades).

2: GETTING THERE

- Use this encounter when the PCs decide to leave the city and travel toward the ruins of Castle Greyhawk. This encounter assumes that the PCs leave through Marsh Gate (the gate nearest to Castle Greyhawk). If they leave through another gate, modify the encounter as necessary. If time is tight, skip this encounter.

For simplicity, assume that any PC with weapons that had to be left with the City Watch did so at Marsh Gate. Thus, as they leave the city they can retrieve their weapons without any problems. The City Watch do not hinder the PCs in any way as they leave.

Set just north of the junction between the city walls and the Black Wall, Marsh Gate gives access to the southern end of the Foreign Quarter. It is mainly used by wagons bringing piles of waste to the city's refuse tip, which lies at Garbage Hill, outside the western walls. It is also common to see funeral processions bearing bodies to the city's cemetery – also just outside the western wall. Those bound for Castle Greyhawk leave the city by Marsh Gate, heading along the river trail leading to Zagig's Bridge. Two Watch patrols guard the gate Read:

As you retrieve your weapons from the City Watch, several large wagons laden with rubbish and filth pass by on the way to Garbage Hill. Travelers, merchants, and watchmen all get out of the way of the foul-smelling carts.

The PCs are free to leave the city.

DEVELOPMENT

Proceed to Encounter Three. DM Maps 1 and 2 shows the location of the ruins in relation to Greyhawk City.

3: THE RUINS LEARNING MORE

In this encounter, the PCs finally reach the ruins of Castle Greyhawk and meet the Wartower Wardens. Read:

A small, squat building stands just outside the shattered ruin of the Tower of War. The building is of grey stone and is obviously of much newer construction than the surrounding ruins. A lone dwarf sits outside, sitting on a shattered stone block. He is smoking a long pipe.

When the PCs approach the dwarf or enter his field of vision, continue:

At your approach, he looks up. "Well met, strangers. You have the look of adventurers about you. Have you come to try your luck in the War Tower?"

This is Grebold Blitzhame (LN male dwarf fighter 5). A member of the Wartower Wardens he shares this guard duty with this brother, Thren (who watches here at night).

If the PCs confirm that they are here to explore the War Tower, Grebold insists that they speak with Stillguar, leader of the Wartower Wardens. Grebold calls inside and presently, a grizzled dwarf emerges. If the PCs try to enter the tower without speaking with Stillguar, the entire guild turns out to stop them. See Development for more details.

Stillguar explains that the Wartower Wardens controls access to the ruins and that to enter, the PCs must promise to pay 25% of the treasure to the guild when they leave. To facilitate this, the dwarves demand that they inventory the PCs' possessions and wealth so that they only tax what the PCs find.

STILLGUAR

Short, stocky and heavily bearded this muscled dwarf carries an axe at his side and has an air of authority about him.

Attitude: Indifferent (PH 72).

What He Knows: See Learning More.

Background: Stillguar has dwelt here for two decades, taxing adventurers seeking to enter the War Tower. In that time he has seen many things and is happy to paint a lurid picture of the terrors lurking in the dungeons below the tower.

The PCs may have some questions for Stillguar. His responses to such questions appear below:

Have you seen any bandits around here? No. (A DC 20 Sense Motive check reveals that Stillguar is holding something back. If the PCs push this point and threaten to tell the free city's authorities that bandits have been using the tower, Stillguar drops his demand to 10% of treasure found as long as they promise to keep the knowledge to themselves. He denies helping the bandits but argues that everyone should be allowed access to the ruins, no matter their personal philosophy.

Has anyone recently entered the War Tower? A small group of adventurers went into the tower two days ago. They have not yet returned.

Why are you here? We of the Wartower Wardens believe that much wealth lies unclaimed in the dungeons below. We guard this entrance to claim a fair share.

How long have you done this? About 20 years.

DEVELOPMENT

If the PCs try to muscle their way into the tower without speaking to, and making a deal with, the Wartower Wardens twelve members of the guild emerge from the guildhouse to stop the PCs. In total, the PCs are confronted by 10 guards (LN male dwarf fighter 4) and 2 lieutenants (LN male dwarf fighter 7). If combat ensues, use the statistics starting on page 110 of the *Dungeon Master's Guide*. The dwarves beat the PCs unconscious, steal half their coin wealth and deposit the PCs outside the ruins.

If the PCs agree to Stillguar's demands, the PCs may enter the dungeons.

Only two of the adventure zones for this final round of "Greyhawk Ruins" is actually accessible from the War Tower.

- **CGR8-02:1 A Short Way with Little Knowledge:** Travelers waylaid, caravans attacked, no survivors, all in the plain of Greyhawk. Someone thinks he knows who is responsible and he plans on doing something about it. It is a short way with little knowledge. This adventure is a loose sequel to COR6-04 *A Long way for a little knowledge*.
- **CGR8-02:4 The Tomb of Pelor:** An ancient, forgotten temple is corrupted by insidious evil.

It does not matter which zone the PCs explore first.

A Short Way with Little Knowledge

By Jean-Philippe “JP” Chapleau

ADVENTURE BACKGROUND **KAYLAN BRUNZEL**

A massive earthquake ravaged the fourth level under the Tower of War in the early 580s. In the years before the earthquake, a number of Nerull-worshipping duergar (grey dwarves) used the area as a barrack. They trained as soldiers in the hopes of taking over the upper levels of the tower. They smuggled slaves from other areas here and worked the stone to make themselves strong.

The earthquake killed most of the duergar, ending their plans. The duergar who survived used their skills in necromancy to transform dead slaves and comrades into zombies and skeletons to work the stone. Soon they turned on each other until only a single duergar lived. He commanded the undead to build and expand the complex.

Eventually, however, he was taken and killed by the oozes in Room W506.

THE IUZIANs COME

Forces loyal to Iuz currently occupy most of this level. What few areas they do not control, they barricaded or made impassable. Yet some areas are still unknown to them. The arrival of the forces of Iuz didn't change things in the remain of the duergars' complex, since it was pretty much sealed off from the outside.

The Iuzians have hired a thug from Greyhawk City named Kaylan Brunzel. Kaylan draws money from the Iuzians and uses his contact in the Greyhawk Thieves' guild to give the Iuzians information about the militias' activity and making himself valuable.

Kaylan's knowledge of the area, the secrets ways into Greyhawk, the caravan schedules, the Coinswords' movements and other information make him a valuable resource.

Using his ability to turn into a rat, Kaylan explored areas unavailable to his allies. Kaylan found the isolated duergar caverns by squeezing through small holes. He has not shared this discovery with his partners.

Kaylan is a natural wererat. (Unsurprisingly, Kaylan is a devout follower of Raxivort, the lord of the rats, wererats and xvarts.) Born in Greyhawk, he grew up on the streets and joined the thieves' guild at an early age. He grew to some power, but was never fully trusted by the leadership. Suspicious of him, his superiors never let him do too much.

Whatever the case, Kaylan has made himself the leader of a group of wererats who are extremely loyal to him. Most of those wererats come from Greyhawk, but some come from other nations around the Nyr Dyv, such as the County of Urnst or the liberated Admunfort.

His ability to turn into a dire rat helped him significantly in gathering information and eavesdropping. After all, it was just a rat...

Kaylan Brunzel and his wererat friends use the halls as their stash where they hide items they stole from across Shatterstone and other places.

THE COMPLEX TODAY

The caves are irregular. The quality of the stonework varies significantly, depending on when they were crafted. Notes about the craftsmanship of each one of the rooms appears in the "Craftsmanship" section.

The earlier chambers (dug by the duergar) are of definite dwarven craftsmanship. The rooms lack decoration and the walls are bare, except where noted.

Illumination: The rooms are light by occasional *continual flame* covered objects left behind by the duergar. For simplicity, dim illumination fills the whole area meaning that PCs with darkvision or low-light vision see normally.

Smell: There is a strong animal musk in the whole area. The place smells of wet fur.

Ceiling: Except where mentioned otherwise, all ceilings are 10-feet high.

Doors: All doors are unlocked, made of stone and are 2 inches thick.

THE GUILD STRIKES BACK

Kaylan's boss in the guild, Eyepatch Jurken, never really liked or trusted him. Eyepatch became suspicious of Kaylan when he heard that Kaylan was trying to fence items known to have been on caravans heading west, towards the Wild Coast.

Using some other guild members, Eyepatch has Kaylan followed into Castle Greyhawk. There Kaylan stayed a short while and left with treasure he did not have before and headed to Greyhawk to pawn it.

ADVENTURE SUMMARY

Introduction: The PCs meet up at the Black Dragon Inn where they meet with Eyepatch Jurken, an enforcer for the Thieves' Guild who has an idea who is responsible for the bandit attacks. The PCs are asked to take care of the problem.

1: In Town: The PCs may visit a few locations in Greyhawk and gather some information before proceeding to the ruins of Castle Greyhawk.

W501: The Entrance: The PCs arrive in the complex through this room

W502: The Common Room: The PCs are attacked by Kaylan's wererat thugs.

W503: The Spare Room: The PCs meet some unthreatening digger zombies in this room and look for treasure.

W504: The Dining Room: Where the PCs find a dead gnome and old supplies.

W505: The Boss's Room: Where the PCs find and talk to Kaylan Brunzel, head of the wererats.

W506: The Treasure Room: Where the PCs find that unguarded treasure is rarely unguarded.

Conclusion: Where the PCs get rewarded or not for their actions.

PREPARATION FOR PLAY

Before starting, hand the affiliation briefings to the PCs where applicable.

INTRODUCTION

Use one of the two introductions below.

PCS WITHOUT INVITATION

This introduction is for PCs who have not been told to head to the Black Dragon Inn in Clerksburg.

Your arrived in Greyhawk City earlier today and set out to find a suitable inn. Fate brought you to the Black Dragon Inn in Clerksburg. There you found a comfortable room, a warm meal and a tasty drink.

Other adventurers are also in the Inn's common room. Conversation naturally sprung up between you.

Allow the PCs to introduce their characters to each other. Then proceed to "Eyepatch Jurken".

PCS SENT TO THE BLACK DRAGON INN

This introduction is for PCs who have been told to head to the Black Dragon Inn in Clerksburg.

You entered the Black Dragon Inn just as the sun disappears over the western horizon. A few other adventurers were seated around the common room. Obviously, you are not the only one who came to the meeting. Conversation naturally sprung up between you.

Allow the PCs to introduce their characters to each other. Then proceed to "Eyepatch Jurken".

"EYEPATCH" JURKEN

Eyepatch Jurken makes the assumption that the adventurers he finds at the Black Dragon Inn have been sent by the Thieves' Guild. Keep this in mind. This may lead to some interesting situations where the PCs are somewhat confused. That's fine.

Eyepatch needs someone to do the job, and any adventurers, even inexperienced ones suit his purpose.

A dirty man with a very long nose enters the room. His right eye is covered by an eye patch of black cloth. His long cloak barely hides the studded leather armor beneath or the rapier hanging at his side.

He looks at your small group for a moment before walking up to the innkeeper. Miklos, the innkeeper hands him a key and the man heads for one of the private rooms.

PCs making a DC 20 Knowledge (local-Core) to recognize the man as Eyepatch Jurken, one of the leaders of the Thieves' Guild and a man with a sordid reputation (some whispers he is one of the head assassins of the guild (he is not, but he is one of the Guild's leading enforcers). Members of the Thieves' Guild automatically recognize him.

Eyepatch's right eye is an empty socket. He does not swap sides.

Miklos is obviously scared of Eyepatch (with reason).

Five minutes later, Miklos Dare (the innkeeper) approaches you and says in a trembling voice. "Please head to the back room, your man is waiting for you."

He shows you into the back room. Amongst the barrels of ale and hanging pans, the man you saw earlier is sitting, cleaning his nails with a dagger.

"Good! You're here. We have much to talk about. For those of you from outside Greyhawk, people call me Eyepatch Jurken; I have need of your services to smoke out a rat."

“You may have heard that a number of convoys and small groups of travelers have been attacked and killed west of here. Well, there is this guy, Kaylan Brunzel, who I’m sure is behind these attacks. If he does not perform the attacks himself, then he works with someone who does.”

“Kaylan used to work for me... Good at his job, but someone I could never trust. I had him followed. He and his boys disappeared into the ruins of the Tower of War of Castle Greyhawk. And he wasn’t adventuring, if you catch my drift...”

“I want you to enter the Tower and punish him for his crimes.” Eyepatch none too discreetly pats his rapier for emphasis.

At APL 2 & 4, add: *“One of the men who followed him saw him transform into a dire rat. Now this means one of two, either he is a druid, or he’s a wererat. And I know he’s no druid. Get yourselves some silver weapons before leaving town.”*

The PCs very likely have questions for Eyepatch. It is obvious that Eyepatch does not like Kaylan.

Why us? Weren’t you sent here? Well no matter, adventurers are fine and I’m sure you’ll be able to get Kaylan.

Where is he in the tower? In the depths of the Crypts of the Forgotten, a wall has collapsed revealing a natural shaft that leads to an isolated set of caves devastated by an earthquake some time ago. (W501.) It is here that he lurks.

Note: Be sure that the PCs learn this information as it stops them wandering around aimlessly looking for Kaylan.

What did Kaylan do for you? He was an enforcer. (Eyepatch won’t say, but Kaylan was an assassin among other things)

Why are you sure he is behind this? He tried to fence items we know were on some of the caravan that got attacked.

You want us to kill him? If it is more convenient to you.

Can we bring him back alive? Sure, whatever suits you! (Eyepatch would rather see Kaylan and his boys killed.)

Who do you work for? Friends (Eyepatch will not say he works for the Thieves’ Guild.)

What if we bring him to the Watch? You can, but risk him escaping through his friends there. (Eyepatch believes this, but doing so gets Kaylan to justice. There is no way for the PCs to really know what will happen.)

Is he a wererat? (At APL 2&4) Yes. (At APL 6&8) I don’t know, maybe.

Is there anything you can give us? No, but I arranged for items of interest to adventurers to be made available at Eridok’s supplies. Just go see him about “Eyepatch’s stuff”.

Does he have the Chalice of St Cuthbert? Yes, we think he does have it. He hinted at having it when he was out drinking one night.

What does it pay? I’m no ingrate and the people whom I represent would be thankful.

Do we have a time limit? Every minute wasted gives him a chance to escape. (To the DM: there is no time limit in this adventure, just try to give the PCs a sense of urgency.)

How do we find you? Leave a note here or at Eridok’s and I’ll meet with you. (Actually, Eyepatch will post watchers at all the main gates looking for the PCs.)

All APLs

☛ **Eyepatch Jurken:** rogue 10, N (with evil tendencies).

TROUBLESHOOTING

PCs with affiliations who have been sent here to meet with Eyepatch and who refuse to help lose 1 affiliation point.

Other PCs who refuse to help may leave without any adverse repercussions.

I: IN TOWN

This is a series of mini-encounters the PCs may wish to pursue before heading out to the ruins.

ERIDOK’S SUPPLIES

Eridok met with Eyepatch the other day and was asked to come up with a series of useful items for adventurers. Eridok does not know Eyepatch, but he was promised decent money so he agreed. Eridok was not coerced to help the PCs. He guesses they are working with the Thieves’ guild.

Items he has for the PCs include:

- Ring of climbing (DMG, 2,500 gp)
- Ring of jumping (DMG, 2,500 gp)
- Ring of swimming (DMG, 2,500 gp)
- Silversheen (DMG, 250 gp)
- Wand of protection against evil (DMG, 50 charges, 750 gp)
- Wand of resurgence (SpC, 10 charges, 150 gp)

If a PC buys any of these items have him note the purchase in the Items Bought section of his AR.

WORD ON THE STREETS

The PCs can learn the following rumors with a successful Gather Information check. They gain all the information at the lower DC’s as well. For every 10 gp they spend, they gain a +1 circumstance bonus (up to +4).

- **DC 10:** There has been a lot of bandit activity in the west of the domain recently.
- **DC 15:** Bandits stole a relic from the church of St Cuthbert.

- DC 20: Items stolen from the caravans have been pawned around the town.

THE CHURCH OF ST CUTHBERT

Anyone at the Church does not deny that a relic was stolen while on its way to Safeton, but all insist that “it is being taken care of”.

FENCES & PAWN SHOPS

While everyone in town knows that items stolen from caravans and travelers have been pawned off in town, no one knows where or who bought what. PCs doing this should quickly get the impression that many of the pawn shop could purchase then sell items.

W501: THE ENTRANCE

The walls of this cave are un-worked stone and slick with liquid. Mosses and fungi grow on the walls. A musty smell of rot and refuse is strong here.

The floor of this room is hidden by a layer of dark and foul water. Rats and other vermin move around the murky surface of this vile soup.

A rough stone corridor leads out towards the south.

This is he the chamber through which the PCs enter kaylan’s lair. The PCs climb down a natural shaft in the ceiling (DC 5 Climb check required). The shaft is 40 ft. deep before it opens into the chamber. There are many places where the PCs can secure a rope.

This room has a ceiling about 50 feet higher than the norm; this “room” was opened by the earthquake and was not part of the duergars’ original design.

A series of crevasses and recesses link this chamber to the levels above. The occupants of the top levels throw waste and trash into a number of small holes and cracks and many of them end up. Though it is not immediately obvious, a number of springs drop into this room.

The water in this room filters down to the lower levels of the tower.

There is no danger, creature or trap in this room. Searching through the water is disgusting and yields nothing of value.

Though there are no dangers in this room, if the PCs spend too much time in this room or if they make a lot of noise (searching through the water would be considered noisy), the PCs alert the wererats in room W502. Use your own judgment in determining if the wererats become aware of the PCs.

Craftsmanship: Low quality and natural stone. This room is not worked, having been created by the earthquake. The Duergar did not spend any time working on this part of the complex.

W502: THE COMMON ROOM

Rats are ever present in this debris-filled room as they scuttle about your feet. Light comes from continual flames glowing from the occasional item lying on the floor. The musty smell of wet fur is almost overpowering. The squeaking of rats echoes through the room.

On the southern edge of the room, three large-size stone statues of skeletal creatures line the wall.

“Intruders!” calls out a voice from the back of the room, revealing a human-sized creature with rat features. Rats scurry about him.

APL 2 (EL 2)

☞ **Wererat Leader, hybrid form:** monk 1/warrior 1; hp 25; Appendix 1.

APL 4 (EL 6)

☞ **Dire Rats (6):** hp 5 each; MM 64.

☞ **Wererat Leader, hybrid form:** monk 1/warrior 1; hp 25; Appendix 1.

☞ **Wererat, hybrid form (2):** hp 12 each; MM 171.

APL 6 (EL 8)

☞ **Advanced Dire Rats (6):** hp 26 each; Appendix 1.

☞ **Wererat leader, hybrid form:** monk 3/warrior 1; hp 39; Appendix 1.

☞ **Wererat thug, hybrid form (2):** rogue 2/warrior 1; hp 34 each; Appendix 1.

APL 8 (EL 10)

☞ **Advanced Dire Rat Mob:** hp 195; Appendix 1.

☞ **Wererat leader, hybrid form:** monk 3/warrior 1; hp 39; Appendix 1.

☞ **Wererat thug, hybrid form (3):** rogue 2/warrior 1; hp 34 each; Appendix 1.

Tactics: Any rats have been trained in the “guard” trick and attack any non-wererat (or rat) leaving the tunnel leading to room W501.

EXPLORING THE ROOM

When the duergar were in charge of the complex, this room served as their barracks and common room. The wererats removed the tables and chairs and have turned this into a nursery for their pet dire rats. It is also the main guard room.

Craftsmanship: This room was worked on by duergar and has exquisite craftsmanship.

The Statues: The statues were crafted by the duergar after the earthquake and were not part of the original room. They depict skeletal creatures (if you have Large-sized skeletal miniatures, use those otherwise assume they represent giant skeletal dwarves [actually duergar]). Symbols of a skull and scythe are visible on them when seen up close.

A DC15 Knowledge (religion) recognizes the symbols of Nerull, NE Flan god of darkness, death, murder and the Underworld.

The statues are just that, stone statues. Destroying them is noisy, but simple. No stats are provided for them. If the PCs want to destroy them, they do so.

W503: THE SPARE ROOM

The first thing you hear when you open the door to this room is the dull, slow, rhythmic banging of fists against stone. On the eastern wall of the room, about half a dozen rag-wearing humanoids aimlessly bang on the stone wall before them, as if trying to escape.

Two natural crevasses occupy the center of the room. From the smallest one emanates a sickly reddish glow basking the room in its hue.

The floor is clear of debris and shows a variety of construction. To the west is common stonework. Then a patch of rough stone and finally the floor on the eastern side of the room is of elaborately carved marble with skull motifs.

At the north end of the room, a natural cavern opens up.

APL2

At APL 2, a group of dire rats has entered the room and were locked in by accident. Not being trained to attack the zombies, they avoided them. The rats are now extremely hungry, and, consequently, attack immediately.

At all other APLs, there are no creatures in the room.

APL2 (EL3)

➤ **Advanced Dire Rats (3):** hp 26 each; Appendix 1.

Tactics: The dire rats swarm the first person in front of them and then whoever hits them for the most damage.

THE ZOMBIES

The zombies are no threat to anyone. They do not attack, even if attacked. If moved, pushed or disturbed, they simply move to another section of wall and begin hitting the stone again.

All APLs

➤ **Duergar zombies (5):** hp 3 each (due to damage from walls); use human zombie statistics if needed; MM 274.

➤ **Human zombies (2):** hp 3 each (due to damage from walls); MM 274.

EXPLORING THE ROOM

Before the earthquake, this room did not exist. The eastern end of the room was a temple to Nerull and the western side was a corridor.

After the earthquake, the duergar send their zombie and slaves to work here to re-open the temple. The duergar overseers died before their undead minions were able to complete their task.

Today, there still are a few zombies in this room. They have been tasked with digging and so they dig. With time, their tools have dulled and broken. Now they simply hit the stone with their hands with no appreciable result.

The wererats decided to leave them here and use the back room as a storage room.

Craftsmanship: This room shows a mixture of craftsmanship, the eastern side of the room (where the temple is) has a lot of intricate details of skulls motifs on the floor. The central and northern part of the room has been worked on by the zombies and the craftsmanship is poor at best.

The Glowing (small) Crevasse

The small crevasse is about 10 feet deep. At the bottom lies a statue of a skeletal creature with rust-red skin dark green ropelike hair, wearing a black cowl and carrying a red-veined staff.

Around the statues are a number of broken bones. The red glow emanates from a number of those bones.

The statue simply fell into a hole opened by the earthquake and the duergar did not have the time to get it out.

A DC15 Knowledge (religion) recognizes the statue as a depiction of one of Nerull's many avatars (NE Flan god of darkness, death, murder and the Underworld.)

The glowing bones are remnants of the altar that used to be in the temple. The altar was broken in the earthquake, but a number of its shards still had *continual flames* active on them. The duergar tossed the bones in the hole as a manner of convenience.

A DC 15 Heal check identifies those bones as dwarven in origin (duergar to be precise, but there is no way to know for sure). Making a DC 25 Heal check reveals that the bones are at least 15 years old.

The staff held by the statue is a *skeletal runestaff* (Appendix 2). It can not be removed without breaking the statues' hand. There is no ill-effect to doing so, do not discourage the PCs from worrying about doing so.

The staff radiates strong auras of necromancy and abjuration (Spellcraft DC 21). Its name (*skeletal runestaff*) and powers can be read using a *read magic* spell in the red veins.

The Large Crevasse

This crevasse is roughly twenty feet long and about ten feet wide. The crevasse is about five feet deep, and has been filled with rubble and other debris.

This crevasse was used by the duergar to clear out this room. It is much deeper, but has been filled almost to the top. There is nothing of interest here.

The Back Room

This rough-stone room has furniture packed inside. The furniture is old and shows signs of neglect and decay. This room is extremely dusty and the trails of the ever-present rats can be seen everywhere.

The duergar used this room as a storage room while they rebuilt their lair. The wererats have not really done anything here. There is nothing of value amongst the furniture.

W504: THE DINING ROOM

This room has a smell of saffron and other exotic spices about it. A small table covered with arcane etchings stands in the center of the room. Upon the table lie the half-eaten remains of a gnome. Dozens of small rats feast on the carcass.

The craftsmanship in this room is exquisite and of high quality. The walls have carved-out stone shelves upon which rest a series of vials, bottles, smaller containers and opened bags of grain.

On the eastern edge of the south wall a collapsed tunnel indicates where once a passage stood. It is now filled with stone and rubble.

To the west, another door pierces the wall.

There is no danger in this room, but should the PCs make a lot of noise, Kaylan in Room W505 gets ready for battle.

EXPLORING THE ROOM

This room (and the now-blocked room to the south-east) was a pantry. Strangely enough, this room was spared in the earthquake, suffering only minor damage that was quickly repaired.

The shelves contain food (some spoiled some still good, mostly pickled fungi) without value. These fungi are not dangerous but are an acquired taste favored by the duergar.

There are two bottles of Blackmoor Brandy (there is a "For men only: drink with caution" label written in Undercommon that appears below a powerful-looking dwarf)

Note: Blackmoor Brandy is illegal to sell in most civilized countries (including the Domain of Greyhawk) and it may cause death or blindness (300-proof alcohol). Anyone drinking this must make a DC 15 Fortitude save or go blind for about a week (1TU). They also receive the "Blind!" AR Reward. The blindness is immediate.

Anyone who succeeds at a DC 10 Knowledge (local: -any) check, or any alcohol-related Profession or bardic knowledge check, informs the PC of the fact that it is illegal in Greyhawk. The same check at DC 15 informs the PC that many people who have drunk Blackmoor Brandy have gone blind.

Due to its illegal nature, the brandy has no resale value.

Craftsmanship: This room was worked on by Duergar and has exquisite craftsmanship.

The Gnome

The wererats were about to throw this body to the gelatinous cube. He has been searched and has nothing of value on him.

A DC15 Heal check reveals he was killed by Medium-sized piercing weapons.

If the PCs have access to *speak with dead*, or similar spell, the corpse relates that his name was Wayside Bumblemarchenshmaytenfrink (or Wayside Frink for the uneducated). Baravar's spirit speaks with anyone devoted to a gnomish deity without resisting.

Wayside was devoted to Baravar Cloakshadow (NG gnomish deity of illusions traps and wards) and hails from a small community in the Cairn Hills. After he heard of the treasures a fellow adventurer found in the ruins, he decided to try his own luck, but was captured and killed by the wererats. Wayside would really like to be returned to his family for burial or for *raise dead*.

W505: THE BOSS' ROOM

The room beyond is lit by a large number of blue candles that bask the room in a soothing glow. The walls here are covered with once-lush tapestries depicting bald dwarves commanding armies of undead and humanoid servants.

Behind the desk stands a tall rat-man holding two short swords. In a Greyhawk accent, he speaks in a high pitched voice.

"Well, well... What have we here... What can I do for you?"

Kaylan is no fool. He guesses (correctly) that the PCs are here at the behest of one of his enemies and are here to kill him. Kaylan is more than willing to talk to the PCs. His goal is to have some of their buff spells expire while they talk.

Note that though Kaylan is lawful in alignment, he has no problem lying or cheating the PCs. His Bluff check at all APLs is -1. Kaylan is willing to promise pretty much anything if the PCs agree to spare his life.

A fight erupts as soon as one of the PCs makes an offensive gesture towards Kaylan or starts casting a spell. Proceed to "Fighting Kaylan".

Here are a few things he might say or answer. Remember his goal is to get the PCs to talk for as long as possible. He does not seriously believe they will leave him alone if offered treasure so he tries to delay.

Who are you? I am Kaylan Brunzel from Greyhawk City. (True).

Did you kill the gnome? We had to, he attacked us first. (True).

Why would your old boss want you killed? Jealousy about my being a wererat!

What are you doing here? I am trying to live my life in peace, but now you have come to kill me I suppose... Perhaps we could make a deal?

Do you offer anything to save your life? I offer you coins in return to my life. I know where large amount of them can be found. I haven't been able to get them myself because I did not wish to share it with the others.

How much money is there? There are many coins, but I'd say at least (APL x 1,000gp total), in all type of coins. I've seen coins from Dyvers, Urnst, the Pomarj and the Empire of Iuz. (True and false. Yes there are coins of all those countries, but there are not that many!)

Why do you offer this to us? My life is worth more than a few coins I can gather while adventuring. (True).

What do you keep in the treasure room? Why our treasure of course! (True).

Is the treasure guarded? Yes, by some incorporeal creatures (It is guarded, but not by incorporeal creatures).

Where is it? (Kaylan agrees only if the PCs promise him his life, ideally someone who seems to be the lawful-type, like priests of St Cuthbert or Heironeous) It is hidden in the walls in a crevasse in the next room (W506).

Do you know where the Chalice of Zeal is? Yes. (True, after some asking, he will say that it is somewhere in the treasure room).

If we let you go, do you promise to stop? Yes, I will leave Greyhawk never to return. (Kaylan is willing to keep this promise.)

Where will you go? I heard that Ahlissa or the Bandit Kingdoms have a lot of opportunity for someone of my talent. (Kaylan does not know where he wants to go).

Can we cure you? If you have the spells available, I would be very grateful. (Kaylan is a natural wererat and therefore can not be cured of it. He knows it, but won't volunteer this information.)

APL 2 (EL 4)

➔ **Kaylan Brunzel:** human wererat fighter 2/ranger 1; hp 38; Appendix 1.

APL 4 (EL 6)

➔ **Kaylan Brunzel:** human wererat fighter 4/ranger 1; hp 56; Appendix 1.

APL 6 (EL 8)

➔ **Kaylan Brunzel:** human wererat fighter 4/ranger 3; hp 72; Appendix 1.

APL 8 (EL 10)

➔ **Kaylan Brunzel:** human wererat fighter 6/ranger 3; hp 90; Appendix 1.

Tactics: Kaylan is a man on his own. He tries to take out PCs as fast as he can to even out the odds, focusing on weaker-looking enemies first.

Kaylan fights to the death neither offering nor asking for mercy.

EXPLORING THE ROOM

The desk in the room is the only interesting feature. Within, the PCs can find a journal in Undercommon and a map of the ancient dungeon. The journal is player handout 1 while the map is player handout 2.

The tapestries depict duergar worshipping Nerull. Kaylan placed them here because he thought they looked better than bare stone walls.

Craftsmanship: This room was worked on by duergar and has exquisite craftsmanship.

DEVELOPMENT

It is possible that the PCs decide not to fight or to let Kaylan go. If this happens, Kaylan heads out as soon as he can and makes a break for it.

W506: THE TREASURE ROOM

A crude latch made of iron that shows beginnings of rust keeps the double stone doors locked. A sign painted in Common hangs on the handles. "Treasure room, keep out! Kaylan"

The door is unlocked and untrapped. This is the only room in the complex that is free of rats and moss. It is also the only unlit room in the complex.

The room is silent and unlit. The floor is rough with large blocks of stone lying broken on the floor. The murmur of water can be heard from the back of the room.

The ceiling reaches fifteen feet in height as the original ceiling seem to now lie broken on the floor.

The smell beyond is not unpleasant... in fact, no smell reaches you and the musty odor of the rest of the complex seems to rush into the room.

The glint of gold and silver sparkles here and there, as though these coins had been nonchalantly scattered on the floor.

This room used to be actually be two rooms used for food storage. Following the earthquake, the rooms received severe damage.

This has attracted a gelatinous cube (or an arcane ooze at APL 8). The cube has grown really fat and big.

When Kaylan and his buddies first came to the caves, they found the ooze in this room. After discussing what to do with it, they decided to leave it there and to have it clean their treasure and get rid of any evidence. So they have fed the ooze with bodies. Since then they gave it items they either do not know what they are or items that are too "hot" to sell in the streets of Greyhawk.

Craftsmanship: This room was worked on by the duergar and their zombies, but was never completed. The ooze here killed the duergar and his zombies

THE CUBES

The gelatinous cube is located somewhere in the room. The arcane ooze at APL 8 is initially in the crevasse in the back of the room.

If running this encounter at APL 8, make sure you familiarize yourself with the arcane ooze's special magic immunity entry.

APL 2 (EL 3)

➔ **Gelatinous Cube:** hp 54, MM 201.

APL 4 (EL 6)

➔ **15 HD Advanced Gelatinous Cube:** hp 232; Appendix 1.

APL 6 (EL 8)

➔ **23 HD Advanced Gelatinous Cube:** hp 356; Appendix 1.

APL 8 (EL 10)

➔ **21 HD Advanced Arcane Ooze:** hp 283; Appendix 1.

Tactics: The ooze waits three rounds before moving towards the door. The oozes move towards the closest moving non-metallic creature.

Clever PCs should find ways to use decoys to draw the cube's attention elsewhere. *Summon* spells or using the zombies from room W503 could be employed very effectively here. Reward creativity with success.

THE CREVASSE

At the back of the room is a crevasse through which a springs flows (and run-offs from room W501). The water flows into a very small (1ft-wide) subterranean watercourse.

There is little of interest here, even though it would seem like a great place to hide something (as Kaylan can hint at [see room W505]).

SEARCHING THE ROOM

Searching through this room is not very difficult, but time-consuming. The PCs can find the following items and about 20 gp in silver and copper coins from nations around the Flanaess (Ekbir, the Pomarj, Urnst, Veluna): an earthsilk jersey^{ROS}, 50ft of earthsilk rope^{ROS}, a grasping hook^{Du} and ten insectbane candles^{A&EG}. The PCs also find a very nice chalice (see "the Chalice" section for more detail on it).

Treasure: Refer to the Treasure Summary to determine what is found here.

The Chalice: Inside one of the gelatinous cubes (or on the floor at APL8) is the Chalice of Zeal. This chalice is covered with symbols of St. Cuthbert. It can be easily identified as belonging to the Church with a DC 10 Knowledge (religion) check.

The Chalice is non-magical but is of great value to the Church. A DC 20 Knowledge (religion) check (Members of the Church of St Cuthbert in Greyhawk automatically know this) tells the PC the following.

- The chalice is rumored to have been touched by St. Cuthbert himself when he walked the Flanaess.
- The calice is a symbol of the faith of the Church of the Cudgel.
- The Church would be very thankful to get it back.

CONCLUSION

Once the PCs return to Greyhawk City, run the PCs through the appropriate conclusion(s).

BROUGHT KAYLAN ALIVE TO EYEPATCH

A few words here and there, and within an hour, a street urchin told you that Eyepatch would meet you at the Black Dragon Inn after sundown.

With the sun gone over the horizon, Eyepatch and five burly half-orcs enter the Black Dragon inn. He heads for your group right away.

"Give me that sniveling toad! I know he is here..."

He shoves Kaylan into the group of enforcers. "Take him to the boss." Turning back to you he says with a smile. "Thanks... he will pay for his crimes. You have done well and I don't forget people who do right by me. I know you kept some items he had on him... Consider them part of your payment..."

Eyepatch turns and leaves, throwing a small bag of coins in your direction. "That should cover it. Farewell!"

Treasure:

All APLs: Coins: 50 gp (in small gems).

BROUGHT KAYLAN ALIVE TO AUTHORITIES

Authorities mean anyone who is not the Thieves' Guild, including but not limited to: the church of St Cuthbert, the Nightwatch or the City Watch.

You had barely returned to the city when a street urchin told you that Eyepatch would meet you at the Black Dragon Inn after sundown.

With the sun gone over the horizon, Eyepatch entered the Black Dragon inn. He heads for your group right away.

"That wasn't what was convened... However, you did bring him to justice... I'll make sure he pays for his crimes. You have done well and I don't forget people who do right by me. I know you kept some items he had on him... Consider them your payment... Not quite what we agreed, but well I didn't quite get what I asked for either."

KAYLAN ESCAPES

Run this conclusion whether the PCs let him escape, refused to fight him or let him go. If the PCs try to avoid Eyepatch, modify the following read aloud text. Eyepatch find the PCs wherever they are in the Domain.

You had barely returned to the city when a street urchin told you that Eyepatch would meet you at the Black Dragon Inn after sundown.

With the sun gone over the horizon, Eyepatch and five burly half-orcs enter the Black Dragon inn. He heads for your group right away.

"That wasn't what was convened! Did I just happen on the biggest band of incompetent this side of Rauxes?" Eyepatch screams at you. "It couldn't've been simpler. Go in, do the job, come out."

"I don't forget people who do me wrong. I won't forget you."

Waving his fist towards you for a moment, Eyepatch gathers himself and leaves with his goons.

KILLED KAYLAN

A few word here, and within an hour, a street urchin told you that Eyepatch would meet you at the Black Dragon Inn after sundown.

With the sun gone over the horizon, Eyepatch and five burly half-orcs enter the Black Dragon inn. He heads for your group right away. He is all smiles.

"I just met with a lovely priestess of Istus who informed me of poor Kaylan's demise! I have to congratulate you on a job well done... You have done well and I don't forget people who do right by me. I know you kept some items he had on him... Consider them part of your payment..."

Eyepatch turns and leaves, throwing a small bag of coins in your direction. "That should cover it. Farewell!"

Treasure:

All APLs: Coins: 50 gp (in small gems).

BROUGHT CHALICE TO CHURCH OF ST CUTHBERT

You are greeted by Brother Jonas at the Temple of the Cudgel. When you pull out the Chalice of Zeal, the brother squeals with delight! With trembling, reverence-filled hands he asks for it.

"The Chalice of Zeal! The holy relic! I thought it was lost to evil forever! Did you know that St Cuthbert himself handled this chalice when he was mortal? It is one of our most precious relics here in Greyhawk. We had thought it lost forever!"

"I can not promise you coin, but the church will certainly offer you magical assistance. Thank you!"

BROUGHT BACK WAYSIDE'S BODY

Any place civilized where gnomes are rather common.

The night after you turned over the gnome's body to a group of rock gnomes (Wayside Bumblemarshmaytenfrink (or Wayside Frink for the uneducated)) you have a very vivid dream. In it a black-cloaked gnome murmured ways to bypass traps and wards. He gave you hints and points. You woke up feeling as though you have been given some sort of premonition.

A little bit of asking around informs you that you may have received a dream from Wayside or from his master, Baravar Cloakshadow, lord of illusions and wards.

AR REWARDS

If the PCs did not bring back Kaylan (alive or dead), they earn the "Eyepatch's Enmity" AR reward.

PCs who brought Kaylan back to Greyhawk (alive or dead, no matter who they gave him to), they earn the "Eyepatch's Gratitude" AR reward.

PCs that drank some of the Blackmoor Brandy and failed the save go blind. They receive the "Blind!" AR reward.

PCs who took the runestaff in room W503 get access to the "Skeletal Runestaff" AR reward.

PCs that brought Wayside's body back (to Greyhawk or to the Cairn Hills) receive the "Blessing of Baravar Cloakshadow" AR reward.

PCs that bring back the Chalice of Zeal to the Church of St Cuthbert receive the "Thanks of the Church of St Cuthbert" AR reward.

Members of the Nightwatch or Thieves' Guild who fail to bring back Kaylan lose 1 point of affiliation.

Members of the Mercenaries' Guild, Nightwatch or the Thieves' Guild who bring back Kaylan gain 1 point of affiliation.

Members of the Church of St Cuthbert who fail to bring back the Chalice of Zeal lose 1 point of affiliation.

Members of the Church of St Cuthbert who bring back the Chalice of Zeal gain 1 point of affiliation.

EXPERIENCE POINT SUMMARY

To award experience for this adventure, add up the values for the objectives accomplished. Then assign the experience award. Award the total value (objectives plus roleplaying) to each character.

W502: The Common Room

Defeat the Guards

APL 2	60 XP
APL 4	180 XP
APL 6	240 XP
APL 8	300 XP

W502: The Spare Room

Defeat the Rats

APL 2	90 XP
-------	-------

W505: The Boss' Room

Defeat Kaylan

APL 2	120 XP
APL 4	180 XP
APL 6	240 XP
APL 8	300 XP

W506: The Treasure Room

Defeat the Ooze

APL 2	90 XP
APL 4	180 XP
APL 6	240 XP
APL 8	300 XP

Story Award

Bringing Kaylan to justice (as long as he does not escape)

APL 2	90 XP
APL 4	135 XP
APL 6	180 XP
APL 8	225 XP

Total Possible Experience

APL 2	450 XP
APL 4	675 XP
APL 6	900 XP
APL 8	1,125 XP

TREASURE SUMMARY

During an adventure, characters encounter treasure, usually finding it in the possession of their foes. Every encounter that features treasure has a "treasure" section within the encounter description, giving information about the loot, coins, and magic items that make up the encounter's treasure.

The loot total is the number of gold pieces each character gains if the foes are plundered of all their earthly possessions. Looting the bodies takes at least 10 minutes per every 5 enemies, and if the characters cannot

take the time to loot the bodies, they do not gain this gold. If you feel it is reasonable that characters can go back to loot the bodies, and those bodies are there (i.e., not carted off by dungeon scavengers, removed from the scene by the local watch, and so on), characters may return to retrieve loot. If the characters do not loot the body, the gold piece value for the loot is subtracted from the encounter totals given below.

The coin total is the number of gold pieces each character gains if they take the coin available. A normal adventuring party can usually gather this wealth in a round or so. If for some reason, they pass up this treasure, the coin total is subtracted from the encounter totals given below.

Next, the magic items are listed. Magic item treasure is the hardest to adjudicate, because they are varied and because characters may want to use them during the adventure. Many times characters must cast *identify*, *analyze dweomer* or similar spell to determine what the item does and how to activate it. Other times they may attempt to use the item blindly. If the magic item is consumable (a potion, scroll, magic bolts, etc.) and the item is used before the end of the adventure, its total is subtracted from the adventure totals below.

Once you have subtracted the value for unclaimed treasure from each encounter add it up and that is the number of gold pieces a characters total and coin value increase at the end of the adventure. Write the total in the GP Gained field of the adventure certificate.

Loot = Looted gear from enemy; Coin = Coin, Gems, Jewelry, and other valuables; Magic = Magic Items.

W502: The Common Room

APL2: Magic: 333 gp; *periapt of wisdom* +2 (333gp); Total: 333 gp.

APL4: Loot: 13 gp; Magic: 333 gp; *periapt of wisdom* +2 (333 gp); Total: 346 gp.

APL6: Loot: 69 gp; Magic: 1,053 gp; +1 rapier x2 (193 gp each); *gauntlets of ogre power* (333 gp); *periapt of wisdom* +2 (333 gp); Total: 1,122 gp.

APL8: Loot: 104 gp; Magic: 1,247 gp; +1 rapier x3 (193 gp each); *gauntlets of ogre power* (333 gp); *periapt of wisdom* +2 (333 gp); Total: 1,351 gp.

W503: The Spare Room

All APLs: Magic: 233gp; *skeletal runestaff* (233gp); Total: 233gp.

W505: The Boss's room

APL2: Loot: 14 gp; Magic: 380 gp; +1 chain shirt (104 gp); +1 short sword (193 gp); *cloak of resistance* +1 (83 gp); Total: 394 gp.

APL4: Magic: 573 gp; +1 chain shirt (104 gp); +1 short sword x2 (193 gp each); *cloak of resistance* +1 (83 gp); Total: 573 gp.

APL6: Magic: 1,407 gp; +1 chain shirt (104 gp); +1 short sword x2 (193 gp each); *cloak of resistance* +1 (83 gp); *lesser*

crystal of acid assault (250 gp); lesser crystal of electrical assault (250 gp); gloves of Dexterity +2 (333 gp); Total: 1,407 gp.

APL8: Magic: 1,407gp; +1 chain shirt (104 gp); +1 short sword x2 (193 gp each); cloak of resistance +1 (83 gp); lesser crystal of acid assault (250 gp); lesser crystal of electrical assault (250 gp); gloves of Dexterity +2 (333 gp); Total: 1,407 gp.

W506: The Treasure Room

All APLs: Loot: 55 gp; Coins: 20 gp; Total: 75 gp.

Conclusion

Eyepatch's payment (only if granted in adventure text).

All APLs: Coins: 50 gp. (In small gems)

Treasure Cap

APL 2: 450 gp; **APL 4:** 650 gp; **APL 6:** 900 gp; **APL 8:** 1,300gp.

Total Possible Treasure

APL 2: 1,095 gp; **APL 4:** 1,277 gp; **APL 6:** 2,887 gp; **APL 8:** 3,116 gp.

ADVENTURE RECORD ITEMS

☛ **Blind!** You drank Blackmoor Brandy and have gone blind. Luckily, you recover after a few days. You must spend 1 TU to recover your sight or pay for a *cure blindness* spell.

☛ **Eyepatch's Gratitude:** This favor can be used in one of two ways. Check when used. [] []

- You may negate one enmity with the Greyhawk Thieves' Guild.
- You may smuggle illegal good into the city once.

☛ **Eyepatch's Enmity:** You angered Eyepatch and he has a lot of friends in Greyhawk. This has the following effects. This enmity does not expire.

- Be prepared to be searched when entering Greyhawk.
- You can not claim free upkeep while in the Domain of Greyhawk. All upkeep costs are doubled for you.

☛ **Skeletal Runestaff:** This runestaff allows you to cast any of the following spells by expending a prepared arcane spell or arcane spell slot of the same level or higher: *command undead* (3/day), *halt undead* (1/day) and

hide from undead (3/day). The skeletal runestaff is covered in reddish veins. (MIC 223).

☛ **Blessing of Baravar Cloakshadow:** When you are the victim of a trap, illusion or ward, you automatically succeed on your next saving throw you have to make. Usable only once; cross off once used.

☛ **Affiliation Score Gained/ Lost:** You have gained/lost ___ points with the ___ affiliation. If you are affiliated with more than one group, add extra notes in the notes section detailing your gain or loss.

☛ **Thanks of the Church of St Cuthbert:** You may exchange this favor for one of the following benefits. Check when used.

- Fulfill the role-playing requirement for Consecrated Harrier (of St Cuthbert).
- Remove the curse of lycanthropy from you or another party member.
- Obtain a free casting of a remove curse or break enchantment by a caster of up to 15th level. May only be used on yourself.

ITEM ACCESS

APL 2:

Earthsilk jersey (Adventure, RoS; 150gp)
Earthsilk rope (Adventure, RoS; 12gp)
Grasping hook (Adventure, Du; 500gp)
Insectbane candles (Adventure, A&EG; 1sp)
Ring of climbing (Core, DMG)
Ring of jumping (Core, DMG)
Ring of swimming (Core, DMG)
Silersheen (Core; DMG)
Skeletal runestaff (Adventure; see above; 4,600 gp)
Wand of protection against evil (Core, DMG, 750 gp)
*Wand of resurgence** (Core, DMG, 10 charges, 150 gp)

APL 4 (all of APL 2 plus the following):
+1 mithral chain shirt (Adventure; DMG; 2,100 gp)

APL 8 (all of APLs 2-6 plus the following):
Lesser crystal of acid assault (CL5th; Adventure; MIC; 3,000 gp)
Lesser crystal of electrical assault (CL5th; Adventure; MIC; 3,000 gp)

APPENDIX 1: APL 2

W502: THE COMMON ROOM

WERERAT LEADER, HYBRID CR 3

Male Rhenee wererat (human) warrior 1/monk 1
LE Medium humanoid (human, shapechanger)
Init +9; **Senses** low-light vision, scent; Listen +3, Spot +3

Languages Common, Rhopan; rat empathy

AC 20, touch 17, flat-footed 15
(+5 Dex, +2 class (Wis), +3 natural)

hp 25 (3 HD); **DR** 5/silver

Fort +9, **Ref** +9, **Will** +6

Speed 30 ft. (6 squares)

Melee unarmed strike +7 (1d6+1) and bite +4 (1d6 plus disease) or

Melee flurry of blow +5/+5 (1d6+1) and bite +2 (1d6 plus disease)

Base Atk +1; **Grp** +2

Atk Options Stunning Fist (DC 13), disease, flurry of blows

Abilities Str 13, Dex 21, Con 14, Int 12, Wis 14, Cha 8
SQ alternate form

Feats Improved Initiative, Improved Unarmed Strike^B, Multiattack, Stunning Fist^B, Iron Will^B, Weapon Finesse^B, Weapon Focus (unarmed strike),

Skills Climb +18, Handle Animal +3 (+7 with rats), Hide +6, Intimidate +3, Jump +6, Listen +3, Move Silently +7, Spot +3, Swim +13, Tumble +9

Possesions *perapt of wisdom* +2

Alternate Form (Su) A wererat can assume a bipedal hybrid form or the form of a dire rat. They do not use this ability during this adventure.

Disease (Ex) Filth fever; bite, Fortitude DC 13, incubation period 1d3 days, damage 1d3 Dex and 1d3 Con. The save DC is Constitution-based.

Rat Empathy (Ex) Communicate with rats and dire rats, and +4 racial bonus on Charisma-based checks against rats and dire rats.

Skills A wererat in rat or hybrid form uses its Dexterity modifier for Climb or Swim checks. It has a +8 racial bonus on Climb checks and can always choose to take 10 on a Climb check, even if rushed or threatened. Wererats have a +8 racial bonus on Swim checks from their dire rat form.

W503: THE SPARE ROOM

ADVANCED DIRE RATS (3) CR 1

N Medium animal
Init +3; **Senses** low-light vision, scent; Listen +5, Spot +4

AC 14, touch 13, flat-footed 11
(+2 Dex, +1 natural)

hp 26 (4 HD)

Fort +6, **Ref** +7, **Will** +5

Speed 40 ft. (8 squares), climb 20 ft.

Melee bite +6 (1d8+3 plus disease)

Base Atk +3; **Grp** +5

Atk Options disease, tricks (attack, attack unnatural, guard)

Abilities Str 14, Dex 16, Con 14, Int 1, Wis 12, Cha 4

Feats Alertness, Improved Natural Attack (bite), Weapon Finesse^B

Skills Climb +11, Hide +5, Listen +5, Move Silently +5, Spot +4, Swim +11

Disease (Ex) Filth fever—bite, Fortitude DC 12, incubation period 1d3 days, damage 1d3 Dex and 1d3 Con. The save DC is Constitution-based.

Skills Dire rats have a +8 racial bonus on Swim checks. Dire rats have a +8 racial bonus on Climb checks and can always choose to take 10 on Climb checks, even if rushed or threatened.

W505: THE KAYLAN'S ROOM

KAYLAN BRUNZEL CR 5

Male human wererat fighter 2/ranger 1
LE Medium humanoid (human, shapechanger)
Init +9; **Senses** low-light vision, scent; Listen +6, Spot +6

Languages Common, Rhopan; rat empathy

AC 23, touch 14, flat-footed 19; Two-Defense
(+4 Dex, +5 armor, +1 shield, +3 natural)

hp 38 (5 HD); **DR** 10/silver

Fort +11, **Ref** +9, **Will** +6

Speed 30 ft. (6 squares)

Melee +1 *short sword* +9 (1d6+3; 19-20) and bite +3 (1d6+1) or

Melee +1 *short sword* +7 (1d6+3; 19-20) and mwk *short sword* +7 (1d6+1; 19-20) and bite +4 (1d6+1 plus curse of lycanthropy plus disease) or

Melee mwk *short sword* +9 (1d6+2; 19-20) and bite +3 (1d6+1 plus curse of lycanthropy plus disease)

Base Atk +3; **Grp** +6

Atk Options Two-Weapon Fighting, favored enemy (human +2)

Abilities Str 16, Dex 19, Con 16, Int 12, Wis 12, Cha 8
SQ alternate form, wild empathy +0

Feats Improved Initiative, Iron Will^B, Improved Toughness**, Track^B, Two-Weapon Defense, Two-Weapon Fighting, Weapon Finesse^B, Weapon Focus (short sword),

Skills Climb +17, Craft (trapmaking) +7, Handle Animal +1 (+5 with rats), Hide +8, Listen +6, Move Silently +7, Spot +6, Survival +5, Swim +10

Possessions +1 *short sword*, mwk *short sword*, +1 *chain shirt*, *cloak of resistance* +1

Alternate Form (Su) Kaylan can assume a bipedal hybrid form or the form of a dire rat. He does not use this ability during this adventure.

Curse of Lycanthropy (Su) Any humanoid or giant hit by Kaylan's bite attack in animal or hybrid form must succeed on a DC 15 Fortitude save or contract lycanthropy.

Disease (Ex) Filth fever; bite, Fortitude DC 13, incubation period 1d3 days, damage 1d3 Dex and 1d3 Con. The save DC is Constitution-based.

Rat Empathy (Ex) Communicate with rats and dire rats, and +4 racial bonus on Charisma-based checks against rats and dire rats.

Skills While in rat or hybrid form, Kaylan uses his Dexterity modifier for Climb or Swim checks. He has a +8 racial bonus on Climb checks and can always choose to take 10 on a Climb check, even if rushed or threatened. He has a +8 racial bonus on Swim checks from their dire rat form.

WS02: THE COMMON ROOM

WERERAT LEADER, HYBRID CR 3

Male Rhenee wererat (human) warrior 1/monk 1
LE Medium humanoid (human, shapechanger)
Init +9; **Senses** low-light vision, scent; Listen +3, Spot +3

Languages Common, Rhopan; rat empathy

AC 20, touch 17, flat-footed 15
(+5 Dex, +2 class (Wis), +3 natural)

hp 25 (3 HD); **DR** 5/silver

Fort +9, **Ref** +9, **Will** +6

Speed 30 ft. (6 squares)

Melee unarmed strike +7 (1d6+1) and bite +4 (1d6 plus disease) or

Melee flurry of blow +5/+5 (1d6+1) and bite +2 (1d6 plus disease)

Base Atk +1; **Grp** +2

Atk Options Stunning Fist (DC 13), disease, flurry of blows

Abilities Str 13, Dex 21, Con 14, Int 12, Wis 14, Cha 8
SQ alternate form

Feats Improved Initiative, Improved Unarmed Strike^B, Multiattack, Stunning Fist^B, Iron Will^B, Weapon Finesse^B, Weapon Focus (unarmed strike),

Skills Climb +18, Handle Animal +3 (+7 with rats), Hide +6, Intimidate +3, Jump +6, Listen +3, Move Silently +7, Spot +3, Swim +13, Tumble +9

Possessions *periap of wisdom* +2

Alternate Form (Su) A wererat can assume a bipedal hybrid form or the form of a dire rat. They do not use this ability during this adventure.

Disease (Ex) Filth fever; bite, Fortitude DC 13, incubation period 1d3 days, damage 1d3 Dex and 1d3 Con. The save DC is Constitution-based.

Rat Empathy (Ex) Communicate with rats and dire rats, and +4 racial bonus on Charisma-based checks against rats and dire rats.

Skills A wererat in rat or hybrid form uses its Dexterity modifier for Climb or Swim checks. It has a +8 racial bonus on Climb checks and can always choose to take 10 on a Climb check, even if rushed or threatened. Wererats have a +8 racial bonus on Swim checks from their dire rat form.

Melee +1 *short sword* +11 (1d6+6; 19-20) and bite +5 (1d6 plus curse of lycanthropy plus disease) or

Melee +1 *short sword* +9 (1d6+6; 19-20) and +1 *short sword* +9 (1d6+4; 19-20) and bite +6 (1d6+1 plus curse of lycanthropy plus disease)

Base Atk +5; **Grp** +8

Atk Options Blind Fight, Two-Weapon Fighting, favored enemy (human +2)

Abilities Str 16, Dex 19, Con 16, Int 12, Wis 12, Cha 8
SQ alternate form, wild empathy +0

Feats Blind-Fight, Improved Initiative, Iron Will^B, Improved Toughness**, Track^B, Two-Weapon Defense, Two-Weapon Fighting, Weapon Finesse^B, Weapon Focus (short sword), Weapon Specialization (short sword),

Skills Climb +20, Craft (trapmaking) +9, Handle Animal +3 (+7 with rats), Hide +9, Listen +6, Move Silently +8, Spot +6, Survival +5, Swim +12

Possessions +1 *short sword* (2), +1 *mithral chain shirt*, *cloak of resistance* +1

Alternate Form (Su) Kaylan can assume a bipedal hybrid form or the form of a dire rat. He does not use this ability during this adventure.

Curse of Lycanthropy (Su) Any humanoid or giant hit by Kaylan's bite attack in animal or hybrid form must succeed on a DC 15 Fortitude save or contract lycanthropy.

Disease (Ex) Filth fever; bite, Fortitude DC 13, incubation period 1d3 days, damage 1d3 Dex and 1d3 Con. The save DC is Constitution-based.

Rat Empathy (Ex) Communicate with rats and dire rats, and +4 racial bonus on Charisma-based checks against rats and dire rats.

Skills While in rat or hybrid form, Kaylan uses his Dexterity modifier for Climb or Swim checks. He has a +8 racial bonus on Climb checks and can always choose to take 10 on a Climb check, even if rushed or threatened. He has a +8 racial bonus on Swim checks from their dire rat form.

WS06: THE TREASURE ROOM

ADVANCED GELATINOUS CUBE CR 6

N Huge ooze

Init -6; **Senses** blindsight 60 ft.; Listen -5, Spot -5

AC 2, touch 2, flat-footed 2

(-2 size, -6 Dex)

hp 232 (15 HD)

Immune electricity, gaze attacks, mind-affecting effects, paralysis, poison, polymorph, sleep and stunning. Not subject to critical hits or flanking

Fort +15, **Ref** -1, **Will** +0

Speed 15 ft. (3 squares)

Melee slam +14 (1d8+7 plus 1d6 acid plus paralysis)

Space 15 ft.; **Reach** 10 ft.

Base Atk +11; **Grp** +24

Special Actions acid, engulf, paralysis

WS05: KAYLAN'S ROOM

KAYLAN BRUNZEL CR 7

Male human wererat fighter 4/ranger 1
LE Medium humanoid (human, shapechanger)
Init +9; **Senses** low-light vision, scent; Listen +6, Spot +6

Languages Common, Rhopan; rat empathy

AC 23, touch 14, flat-footed 19; Two-Weapon Defense
(+4 Dex, +5 armor, +1 shield, +3 natural)

hp 56 (6 HD); **DR** 10/silver

Fort +12, **Ref** +10, **Will** +7

Speed 30 ft. (6 squares)

Abilities Str 20, Dex 1, Con 30, Int-, Wis 1, Cha 1

SQ ooze traits, transparent

Acid (Ex) A gelatinous cube's acid does not harm metal or stone.

Engulf (Ex) Although it moves slowly, a gelatinous cube can simply mow down Large or smaller creatures as a standard action. It cannot make a slam attack during a round in which it engulfs. The gelatinous cube merely has to move over the opponents, affecting as many as it can cover. Opponents can make opportunity attacks against the cube, but if they do so they are not entitled to a saving throw. Those who do not attempt attacks of opportunity must succeed on a DC 16 Reflex save or be engulfed; on a success, they are pushed back or aside (opponent's choice) as the cube moves forward. Engulfed creatures are subject to the cube's paralysis and acid, and are considered to be grappled and trapped within its body. The save DC is Strength-based and includes a +1 racial bonus.

Paralysis (Ex) A gelatinous cube secretes an anesthetizing slime. A target hit by a cube's melee or engulf attack must succeed on a DC 22 Fortitude save or be paralyzed for 3d6 rounds. The cube can automatically engulf a paralyzed opponent. The save DC is Constitution-based.

Transparent (Ex) Gelatinous cubes are hard to see, even under ideal conditions, and it takes a DC 15 Spot check to notice one. Creatures who fail to notice a cube and walk into it are automatically engulfed.

W502: THE COMMON ROOM**ADVANCED DIRE RATS (3) CR 1**

N Medium animal

Init +3; **Senses** low-light vision, scent; Listen +5, Spot +4**AC** 14, touch 13, flat-footed 11
(+2 Dex, +1 natural)**hp** 26 (4 HD)**Fort** +6, **Ref** +7, **Will** +5**Speed** 40 ft. (8 squares), climb 20 ft.**Melee** bite +6 (1d8+3 plus disease)**Base Atk** +3; **Grp** +5**Atk Options** disease, tricks (attack, attack unnatural, guard)**Abilities** Str 14, Dex 16, Con 14, Int 1, Wis 12, Cha 4**Feats** Alertness, Improved Natural Attack (bite),
Weapon Finesse^B**Skills** Climb +11, Hide +5, Listen +5, Move Silently +5,
Spot +4, Swim +11**Disease (Ex)** Filth fever—bite, Fortitude DC 12,
incubation period 1d3 days, damage 1d3 Dex and
1d3 Con. The save DC is Constitution-based.**Skills** Dire rats have a +8 racial bonus on Swim checks.
Dire rats have a +8 racial bonus on Climb checks and
can always choose to take 10 on Climb checks, even
if rushed or threatened.**WERERAT LEADER, HYBRID CR 5**

Male Rhenee wererat (human) warrior 1/monk 3

LE Medium humanoid (human, shapechanger)

Init +9; **Senses** low-light vision, scent; Listen +4, Spot
+4**Languages** Common, Rhopan; rat empathy**AC** 20, touch 17, flat-footed 15; Deflect Arrow
(+5 Dex, +2 class (Wis), +3 natural)**hp** 39 (5 HD); **DR** 10/silver**Resist** evasion**Fort** +10, **Ref** +10, **Will** +7 (+9 vs enchantments)**Speed** 40 ft. (8 squares)**Melee** unarmed strike +9 (1d6+3) and
bite +6 (1d6+1 plus curse of lycanthropy plus
disease)**Melee** flurry of blow +7/+7 (1d6+3) and
bite +4 (1d6+1 plus curse of lycanthropy plus
disease)**Base Atk** +3; **Grp** +6**Atk Options** Stunning Fist (DC 14), flurry of blows,**Abilities** Str 16, Dex 21, Con 14, Int 12, Wis 14, Cha 8**SQ** alternate form, fast movement, still mind**Feats** Deflect Arrows^B, Improved Initiative, Improved
Unarmed Strike^B, Iron Will^B, Multiattack, Stunning
Fist^B, Weapon Finesse^B, Weapon Focus (unarmed
strike),**Skills** Climb +20, Handle Animal +3 (+7 with rats), Hide
+8, Intimidate +3, Jump +14, Listen +4, Move Silently
+9, Spot +4, Swim +13, Tumble +11**Possessions** *gauntlets of ogre power*, *periapt of
wisdom* +2**Alternate Form (Su)** A wererat can assume a bipedal
hybrid form or the form of a dire rat. They do not use
this ability during this adventure.**Curse of Lycanthropy (Su)** Any humanoid or giant hit
by a wererat's bite attack in animal or hybrid form
must succeed on a DC 15 Fortitude save or contract
lycanthropy.**Disease (Ex)** Filth fever; bite, Fortitude DC 13,
incubation period 1d3 days, damage 1d3 Dex and
1d3 Con. The save DC is Constitution-based.**Rat Empathy (Ex)** Communicate with rats and dire rats,
and +4 racial bonus on Charisma-based checks
against rats and dire rats.**Skills** A wererat in rat or hybrid form uses its Dexterity
modifier for Climb or Swim checks. It has a +8 racial
bonus on Climb checks and can always choose to
take 10 on a Climb check, even if rushed or
threatened. Wererats have a +8 racial bonus on
Swim checks from their dire rat form.**WERERAT THUG, HYBRID (2) CR 4**

Male Rhenee wererat (human) warrior 1/rogue 2

LE Medium humanoid (human, shapechanger)

Init +10; **Senses** low-light vision, scent; Listen +4, Spot
+4**Languages** Common, Rhopan; rat empathy**AC** 22, touch 14, flat-footed 18

(+4 Dex, +1 shield, +4 armor, +3 natural)

hp 34 (4 HD); **DR** 10/silver**Resist** evasion**Fort** +7, **Ref** +11, **Will** +3;**Speed** 30 ft. (6 squares)**Melee** +1 rapier +10 (1d6+2; 18-20) and
bite +3 (1d6 plus curse of lycanthropy plus disease)
or**Melee** sap +8 (1d6+2 non-lethal) and
bite +3 (1d6 plus curse of lycanthropy plus disease)**Base Atk** +2; **Grp** +3**Atk Options** flurry of blows, sneak attack +1d6**Abilities** Str 13, Dex 22, Con 14, Int 12, Wis 12, Cha 8**SQ** alternate form, trapfinding**Feats** Improved Initiative, Improved Toughness**, Iron
Will^B, Weapon Finesse^B, Weapon Focus (rapier),**Skills** Climb +19, Handle Animal +3 (+7 with rats), Hide
+7, Intimidate +3, Jump +6, Listen +4, Move Silently
+8, Search +3, Spot +4, Swim +7, Tumble +10, Use
Magic Device +1**Possessions** +1 rapier, masterwork buckler,
masterwork chain shirt, sap**Alternate Form (Su)** A wererat can assume a bipedal
hybrid form or the form of a dire rat. They do not use
this ability during this adventure.**Curse of Lycanthropy (Su)** Any humanoid or giant hit
by a wererat's bite attack in animal or hybrid form
must succeed on a DC 15 Fortitude save or contract
lycanthropy.

Disease (Ex) Filth fever; bite, Fortitude DC 13, incubation period 1d3 days, damage 1d3 Dex and 1d3 Con. The save DC is Constitution-based.

Rat Empathy (Ex) Communicate with rats and dire rats, and +4 racial bonus on Charisma-based checks against rats and dire rats.

Skills A wererat in rat or hybrid form uses its Dexterity modifier for Climb or Swim checks. It has a +8 racial bonus on Climb checks and can always choose to take 10 on a Climb check, even if rushed or threatened. Wererats have a +8 racial bonus on Swim checks from their dire rat form.

W505: THE KAYLAN'S ROOM

KAYLAN BRUNZEL

CR 9

Male human wererat fighter 4/ranger 3

LE Medium humanoid (human, shapechanger)

Init +10; **Senses** low-light vision, scent; **Listen** +8, **Spot** +8

Languages Common, Rhopan; rat empathy

AC 25, touch 14, flat-footed 19

(+6 Dex, +5 armor, +1 shield, +3 natural)

hp 72 (8 HD); **DR** 10/silver

Fort +13, **Ref** +13, **Will** +8

Speed 30 ft. (6 squares)

Melee +1 *short sword* with *lesser crystal of electrical energy assault* +15/+10 (1d6+6; 19-20 plus 1d6 electricity) and bite +5 (1d6+1 plus curse of lycanthropy plus disease) or

Melee +1 *short sword* with *lesser crystal of acid energy assault* +15/+10 (1d6+6; 19-20 plus 1d6 acid) and bite +8 (1d6+1 plus curse of lycanthropy plus disease) or

Melee +1 *short sword* with *lesser crystal of electrical energy assault* +13/+8 (1d6+6; 19-20 plus 1d6 electricity) and +1 *short sword* with *lesser crystal of acid energy assault* +13/+8 (1d6+4; 19-20 plus 1d6 acid) and bite +6 (1d6+1 plus curse of lycanthropy plus disease)

Base Atk +7; **Grp** +10

Atk Options Blind Fight, Two-Weapon Fighting, favored enemy (human +2)

Abilities Str 16, Dex 22, Con 16, Int 12, Wis 12, Cha 8

SQ alternate form, wild empathy +4

Feats Blind-Fight, Endurance^B, Improved Initiative, Iron Will^B, Improved Toughness**, Improved Two-Weapon Fighting, Track^B, Two-Weapon Defense, Two-Weapon Fighting^B, Weapon Finesse^B, Weapon Focus (short sword), Weapon Specialization (short sword),

Skills Climb +24, Craft (trapmaking) +11, Handle Animal +5 (+9 with rats), Hide +11, Listen +8, Move Silently +10, Spot +8, Survival +7, Swim +16

Possessions +1 *short sword* (2), +1 *mithral chain shirt*, *cloak of resistance* +1, *lesser crystal of acid assault*, *lesser crystal of electrical assault*, *gloves of Dexterity* +2

Alternate Form (Su) Kaylan can assume a bipedal hybrid form or the form of a dire rat. He does not use this ability during this adventure.

Curse of Lycanthropy (Su) Any humanoid or giant hit by Kaylan's bite attack in animal or hybrid form must succeed on a DC 15 Fortitude save or contract lycanthropy.

Disease (Ex) Filth fever; bite, Fortitude DC 13, incubation period 1d3 days, damage 1d3 Dex and 1d3 Con. The save DC is Constitution-based.

Rat Empathy (Ex) Communicate with rats and dire rats, and +4 racial bonus on Charisma-based checks against rats and dire rats.

Skills While in rat or hybrid form, Kaylan uses his Dexterity modifier for Climb or Swim checks. He has a +8 racial bonus on Climb checks and can always choose to take 10 on a Climb check, even if rushed or threatened. He has a +8 racial bonus on Swim checks from their dire rat form.

W506: THE TREASURE ROOM

ADVANCED GELATINOUS CUBE CR 8

N Huge ooze

Init -6; **Senses** blindsight 60 ft.; **Listen** -5, **Spot** -5

AC 2, touch 2, flat-footed 2

(-2 size, -6 Dex)

hp 356 (23 HD)

Immune electricity, gaze attacks, mind-affecting effects, paralysis, poison, polymorph, sleep and stunning. Not subject to critical hits or flanking

Fort +17, **Ref** +1, **Will** +2

Speed 15 ft. (3 squares)

Melee slam +21 (1d8+9 plus 1d6 acid plus paralysis)

Space 15 ft.; **Reach** 10 ft.

Base Atk +17; **Grp** +31

Special Actions acid, engulf, paralysis

Abilities Str 22, Dex 1, Con 30, Int-, Wis 1, Cha 1

SQ ooze traits, transparent

Acid (Ex) A gelatinous cube's acid does not harm metal or stone.

Engulf (Ex) Although it moves slowly, a gelatinous cube can simply mow down Large or smaller creatures as a standard action. It cannot make a slam attack during a round in which it engulfs. The gelatinous cube merely has to move over the opponents, affecting as many as it can cover. Opponents can make opportunity attacks against the cube, but if they do so they are not entitled to a saving throw. Those who do not attempt attacks of opportunity must succeed on a DC 17 Reflex save or be engulfed; on a success, they are pushed back or aside (opponent's choice) as the cube moves forward. Engulfed creatures are subject to the cube's paralysis and acid, and are considered to be grappled and trapped within its body. The save DC is Strength-based and includes a +1 racial bonus.

Paralysis (Ex) A gelatinous cube secretes an anesthetizing slime. A target hit by a cube's melee or engulf attack must succeed on a DC 22 Fortitude save or be paralyzed for 3d6 rounds. The cube can

automatically engulf a paralyzed opponent. The save DC is Constitution-based.

Transparent (Ex) Gelatinous cubes are hard to see, even under ideal conditions, and it takes a DC 15 Spot check to notice one. Creatures who fail to notice a cube and walk into it are automatically engulfed.

W502: THE COMMON ROOM

ADVANCED DIRE RATS MOB* CR 8

*DMG II 59

N Medium animal

Init +0; **Senses** low-light vision, scent; Listen +4, Spot +2

AC 10, touch 9, flat-footed 7
(-4 size, +2 Dex, +1 natural)

hp 195 (30 HD)

Fort +19, **Ref** +20, **Will** +17

Speed 30 ft. (6 squares), climb 10 ft.

Melee mob attack (5d6 plus disease)

Space 20 ft.; **Reach** 0 ft.

Base Atk +22; **Grp** +36

Atk Options Improved Bull Rush, Improved Overrun, mob attack, tricks (attack, attack unnatural, guard)

Special Actions disease, trample 2d6+3

Abilities Str 14, Dex 16, Con 14, Int 1, Wis 12, Cha 4
SQ mob anatomy

Feats Alertness, Improved Bull Rush^B, Improved Natural Attack (bite), Improved Overrun^B, Weapon Finesse^B

Skills Climb +11, Hide +5, Listen +4, Move Silently +5, Spot +3, Swim +11

Disease (Ex) Filth fever—bite, Fortitude DC 12, incubation period 1d3 days, damage 1d3 Dex and 1d3 Con. The save DC is Constitution-based.

Mob Anatomy (Ex) A mob has no clear front or back and no discernable anatomy, so it is not subject to critical hits or sneak attacks. A mob cannot be flanked, tripped grappled or bull rushed. Unlike standard swarms, mobs are made up of relatively small numbers of individual creatures, so spells or effects that target specific number of creatures can have an effect on a mob. Each specific creature that is slain, disabled, or otherwise incapacitated by spells or effects that target specific creatures bestows two negative levels on the mob. A mob that gains negative levels equal to its Hit Dice breaks up as if reduced to 0 hit points. Negative levels gained in this manner are not the result of negative energy (and thus cannot be blocked by *death ward* or removed by *restoration*), but never result in permanent level loss.

A mob takes half again as much damage (+50%) from spells or effects that affect an area, such as a splash weapon and evocation spells.

When a mob is dispersed, assume 30% are slain, 30% are reduced to 0 hit points.

Mob Attack (Ex) Mobs don't make standard attacks. Rather, they are treated similar to swarms in combat. A mob deals 5d6 points of bludgeoning damage to any creature whose space it occupies at the end of its move, with no attack roll needed. Mob attacks ignore concealment and cover. A mob's attacks are non magical unless the base creature's attacks are considered magical. Damage Reduction applies to mob attacks.

Trample (Ex) A mob that simply moves over a creature and doesn't end its movement with that creature in one of its occupied squares can trample the creature. A trampled creature takes 2d6+3 points of damage. The victim can either make an attack of opportunity against the mob or make a Reflex save (DC27) to take half damage.

Skills Dire rats have a +8 racial bonus on Swim checks. Dire rats have a +8 racial bonus on Climb checks and can always choose to take 10 on Climb checks, even if rushed or threatened.

Dire rats use their Dexterity modifier for Climb and Swim checks.

WERERAT LEADER, HYBRID CR 5

Male Rhenee wererat (human) warrior 1/monk 3

LE Medium humanoid (human, shapechanger)

Init +9; **Senses** low-light vision, scent; Listen +4, Spot +4

Languages Common, Rhopan; rat empathy

AC 20, touch 17, flat-footed 15; Deflect Arrow (+5 Dex, +2 class (Wis), +3 natural)

hp 39 (5 HD); **DR** 10/silver

Resist evasion

Fort +10, **Ref** +10, **Will** +7 (+9 vs enchantments)

Speed 40 ft. (8 squares)

Melee unarmed strike +9 (1d6+3) and bite +6 (1d6+1 plus curse of lycanthropy plus disease)

Melee flurry of blow +7/+7 (1d6+3) and bite +4 (1d6+1 plus curse of lycanthropy plus disease)

Base Atk +3; **Grp** +6

Atk Options Stunning Fist (DC 14), flurry of blows,

Abilities Str 16, Dex 21, Con 14, Int 12, Wis 14, Cha 8

SQ alternate form, fast movement, still mind

Feats Deflect Arrows^B, Improved Initiative, Improved Unarmed Strike^B, Iron Will^B, Multiattack, Stunning Fist^B, Weapon Finesse^B, Weapon Focus (unarmed strike),

Skills Climb +20, Handle Animal +3 (+7 with rats), Hide +8, Intimidate +3, Jump +14, Listen +4, Move Silently +9, Spot +4, Swim +13, Tumble +11

Possessions *gauntlets of ogre power*, *periapt of wisdom* +2

Alternate Form (Su) A wererat can assume a bipedal hybrid form or the form of a dire rat. They do not use this ability during this adventure.

Curse of Lycanthropy (Su) Any humanoid or giant hit by a wererat's bite attack in animal or hybrid form must succeed on a DC 15 Fortitude save or contract lycanthropy.

Disease (Ex) Filth fever; bite, Fortitude DC 13, incubation period 1d3 days, damage 1d3 Dex and 1d3 Con. The save DC is Constitution-based.

Rat Empathy (Ex) Communicate with rats and dire rats, and +4 racial bonus on Charisma-based checks against rats and dire rats.

Skills A wererat in rat or hybrid form uses its Dexterity modifier for Climb or Swim checks. It has a +8 racial bonus on Climb checks and can always choose to take 10 on a Climb check, even if rushed or threatened. Wererats have a +8 racial bonus on Swim checks from their dire rat form.

WERERAT THUG, HYBRID (3) CR 4

Male Rhenee wererat (human) warrior 1/rogue 2
LE Medium humanoid (human, shapechanger)
Init +10; **Senses** low-light vision, scent; Listen +4, Spot +4

Languages Common, Rhopan; rat empathy

AC 22, touch 14, flat-footed 18
(+4 Dex, +1 shield, +4 armor, +3 natural)

hp 34 (4 HD); **DR** 10/silver

Resist evasion

Fort +7, **Ref** +11, **Will** +3

Speed 30 ft. (6 squares)

Melee +1 rapier +10 (1d6+2; 18-20) and bite +3 (1d6 plus curse of lycanthropy plus disease)

Melee sap +8 (1d6+2 non-lethal) and bite +3 (1d6 plus curse of lycanthropy plus disease)

Base Atk +2; **Grp** +3

Atk Options flurry of blows, sneak attack +1d6

Abilities Str 13, Dex 22, Con 14, Int 12, Wis 12, Cha 8
SQ alternate form, trapfinding

Feats Improved Initiative, Improved Toughness**, Iron Will^B, Weapon Finesse^B, Weapon Focus (rapier),

Skills Climb +19, Handle Animal +3 (+7 with rats), Hide +7, Intimidate +3, Jump +6, Listen +4, Move Silently +8, Search +3, Spot +4, Swim +7, Tumble +10, Use Magic Device +1

Possessions +1 rapier, masterwork buckler, masterwork chain shirt, sap

Alternate Form (Su) A wererat can assume a bipedal hybrid form or the form of a dire rat. They do not use this ability during this adventure.

Curse of Lycanthropy (Su) Any humanoid or giant hit by a wererat's bite attack in animal or hybrid form must succeed on a DC 15 Fortitude save or contract lycanthropy.

Disease (Ex) Filth fever; bite, Fortitude DC 13, incubation period 1d3 days, damage 1d3 Dex and 1d3 Con. The save DC is Constitution-based.

Rat Empathy (Ex) Communicate with rats and dire rats, and +4 racial bonus on Charisma-based checks against rats and dire rats.

Skills A wererat in rat or hybrid form uses its Dexterity modifier for Climb or Swim checks. It has a +8 racial bonus on Climb checks and can always choose to take 10 on a Climb check, even if rushed or threatened. Wererats have a +8 racial bonus on Swim checks from their dire rat form.

W505: THE KAYLAN'S ROOM

KAYLAN BRUNZEL

CR 11

Male Human wererat fighter 6/ranger 3
LE Medium humanoid (human, shapechanger)

Init +10; **Senses** low-light vision, scent; Listen +8, Spot +8

Languages Common, Rhopan; rat empathy

AC 25, touch 14, flat-footed 19; Two-Weapon Defense (+6 Dex, +5 armor, +1 shield, +3 natural)

hp 90 (10 HD); **DR** 10/silver

Fort +14, **Ref** +14, **Will** +9

Speed 30 ft. (6 squares)

Melee +1 short sword with lesser crystal of electrical energy assault +19/+14 (1d6+8; 17-20 plus 1d6 electricity) and bite +12 (1d6+3 plus curse of lycanthropy plus disease) or

Melee +1 short sword with lesser crystal of acid energy assault +19/+14 (1d6+8; 17-20 plus 1d6 acid) and bite +12 (1d6+3 plus curse of lycanthropy plus disease) or

Melee +1 short sword with lesser crystal of electrical energy assault +17/+12 (1d6+8; 17-20 plus 1d6 electricity) and

+1 short sword with lesser crystal of acid energy assault +17/+12 (1d6+6; 17-20 plus 1d6 acid) and bite +12 (1d6+3 plus curse of lycanthropy plus disease)

Base Atk +9; **Grp** +12

Atk Options Blind-Fight, Two-Weapon Fighting, favored enemy (human +2)

Special Attacks

Abilities Str 16, Dex 22, Con 16, Int 12, Wis 12, Cha 8
SQ alternate form, wild empathy +4

Feats Blind-Fight, Endurance^B, Improved Critical (short sword), Improved Initiative, Iron Will^B, Improved Toughness**, Improved Two-Weapon Fighting, Melee Weapon Mastery** (piercing), Track^B, Two-Weapon Defense, Two-Weapon Fighting^B, Weapon Finesse^B, Weapon Focus (short sword), Weapon Specialization (short sword),

Skills Climb +27, Craft (trapmaking) +14, Handle Animal +5 (+9 with rats), Hide +11, Listen +8, Move Silently +10, Spot +8, Survival +7, Swim +18

Possessions +1 short sword (2), +1 mithral chain shirt, cloak of resistance +1, lesser crystal of acid assault, lesser crystal of electrical assault, gloves of Dexterity +2

Alternate Form (Su) Kaylan can assume a bipedal hybrid form or the form of a dire rat. They do not use this ability during this adventure.

Curse of Lycanthropy (Su) Any humanoid or giant hit by Kaylan's bite attack in animal or hybrid form must succeed on a DC 15 Fortitude save or contract lycanthropy.

Disease (Ex) Filth fever; bite, Fortitude DC 13, incubation period 1d3 days, damage 1d3 Dex and 1d3 Con. The save DC is Constitution-based.

Rat Empathy (Ex) Communicate with rats and dire rats, and +4 racial bonus on Charisma-based checks against rats and dire rats.

Skills While in rat or hybrid form, Kaylan uses his Dexterity modifier for Climb or Swim checks. He has a +8 racial bonus on Climb checks and can always choose to take 10 on a Climb check, even if rushed

or threatened. He has a +8 racial bonus on Swim checks from their dire rat form.

W506: THE TREASURE ROOM

ADVANCED ARCANE OOZE* CR 11

**Monster Manual III* 9

N Huge Ooze

Init -5; **Senses** blindsight 60 ft.; Listen -5, Spot -5

AC 3, touch 3, flat-footed 3

(-2 size, -5 Dex)

hp 283 (23 HD)

Immune gaze attacks, magic, mind-affecting effects, paralysis, poison, polymorph, sleep and stunning. Not subject to critical hits or flanking

Fort +15, **Ref** +2, **Will** +2

Speed 20 ft. (4 squares), climb 20ft.

Melee slam +20 (2d6+10 plus 2d6 acid)

Space 15 ft.; **Reach** 10 ft.

Base Atk +15; **Grp** +30

Atk Options acid, constrict 2d6+10 plus 2d6 acid, improved grab

Special Actions spell siphon

Abilities Str 22, Dex 1, Con 26, Int-, Wis 1, Cha 1

SQ ooze traits

Skills Climb +15

Acid (Ex) A arcane ooze's acid only dissolves flesh.

Constrict (Ex) An arcane ooze deals automatic slam damage and acid damage with a successful grapple check.

Improved Grab (Ex) To use this ability, an arcane ooze must hit with its slam attack. It can then attempt to start a grapple as a free action without provoking attacks of opportunity. If it wins the grapple check, it establishes a hold and can constrict.

Spell Siphon (Su) An arcane ooze exerts a strange pull on arcane spell energy. Any time an arcane spellcaster begins his turn within 60 feet of an arcane ooze, he must make a DC25 Fortitude save or lose a random spell of the highest level that he has available. For every spell lost by a victim in this manner, the arcane ooze gains temporary hit points equal to 5x level of the spell lost. These temporary hit points are lost after 1 hour.

Line of effect between the spellcaster and the arcane ooze is necessary in order for this ability to work. The save DC is Constitution-based.

Immunity to Magic (Ex) An arcane ooze is immune to any spell or spell-like ability that allows spell resistance. In addition, certain spells and effects function differently against the creature as noted below.

A magical attack that deals electricity damage increases an arcane ooze's speed as if it had been affected by a haste spell for 3 rounds.

A magical attack that deals acid damage heals an arcane ooze of amount of damage equal to half the acid damage that the spell would normally have caused.

Skills An arcane ooze has +8 racial bonus on Climb check and can always take 10 on a Climb check, even if rushed or threatened.

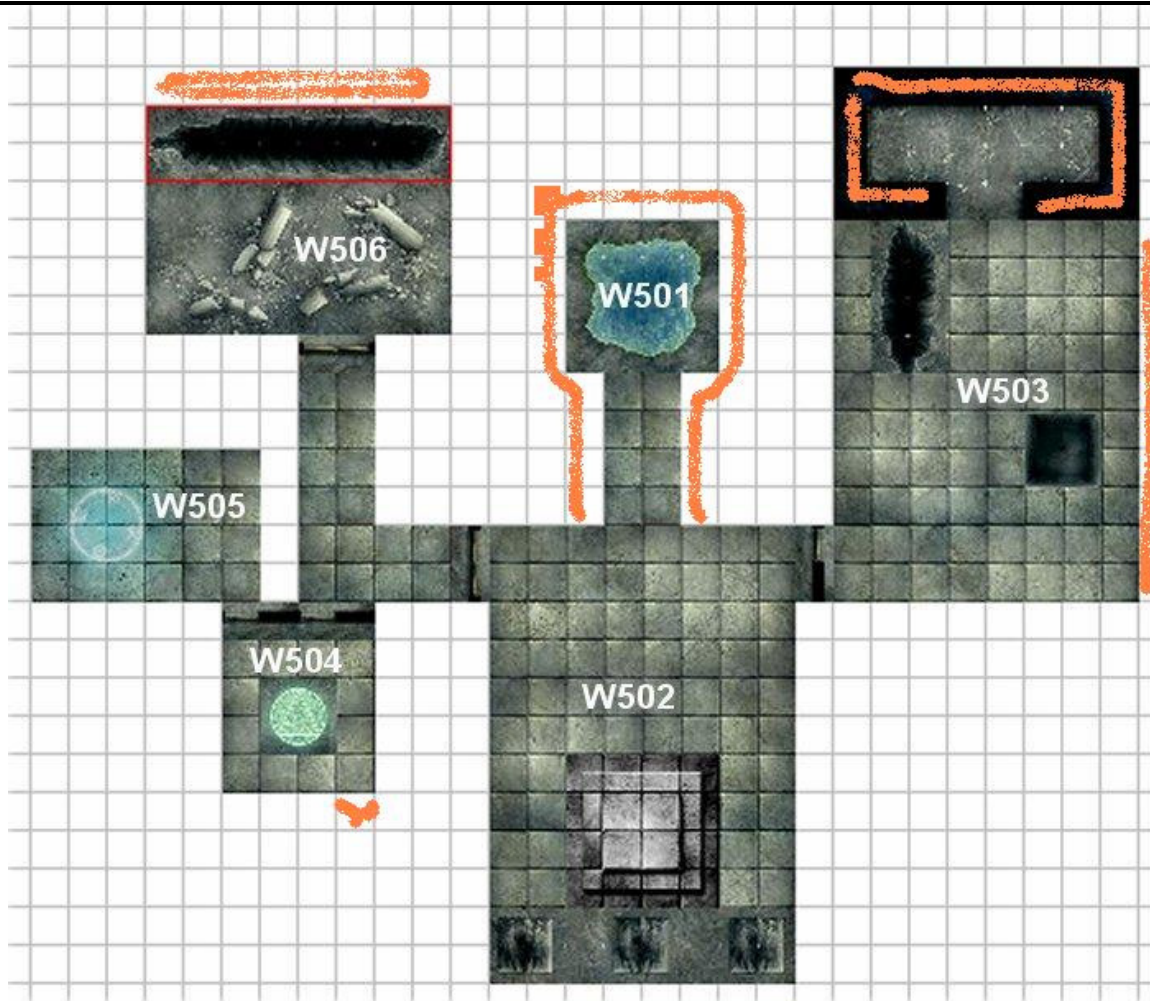

PLAYER HANDOUT 1

The following journal is written in Undercommon. The writing is simple, precise and well-defined.

Planting 579CY

New recruits arrived. Some were used to feed the spiders. This is a good batch. Strong and with a strong desire to serve in the Reaper's army when we take over the whole of the Tower.

Training almost completed on the previous soldiers. They caught a group of intruders coming down the shaft. Need to steel better equipment to rival adventurers.

(Similar entries over the next 15 months)

(The next entries are not dated. There are a number of similar entries where the author tries to assert his dominance due to his relation to "the Reaper".)

A terrible earthquake destroyed most of the caverns. I presume that all the others have been lost. There are only a few of us left. We must reach the temple.

Gaping holes and crevasses have appeared in many places. We solidified them to make sure they are safe enough.

I had to kill some of the insubordinate. They wanted to leave our unhallowed halls. I turned them into zombies and they now dig to re-open a way to the temple. Good servants they are now.

It seems the whole temple has collapsed upon itself. My zombies keep digging and filling a large crevasse, but it is not sufficient. I need more help.

The others and I got into an argument and I had to kill them all and make zombies out of them! Finally they will obey me without question. I had them excavate another way to the temple but that one too seems to be blocked!

(Last Entry)

I heard noises in the food storage. I will go and investigate.

PLAYER HANDOUT 2

Duergar Complex in 579CY
Annotations have been made later.

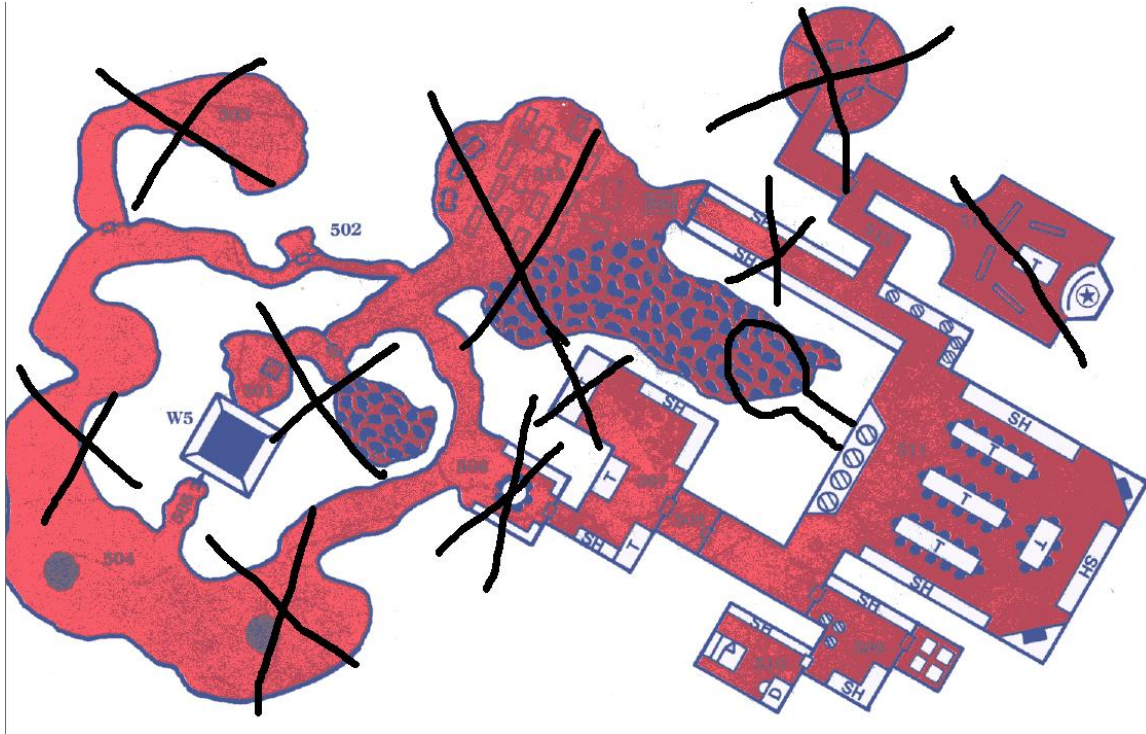

AFFILIATION BRIEFING SHEET



MERCENARIES' GUILD

Mission: While you were drinking at the Guild last night, you met a gnome fighter calling himself the Great Karvin. After a few pitchers, the gnome began to parade about pretending how he got rich while adventuring with his party in the ruins. The gnome said that he was contacted by some big shot wanting him to do some clean-up job he was to meet the man at the Black Dragon after sunset.

The Great Karvin won't make his rendezvous, since shortly after he got into a fight with a burly half-orc and got pummeled after calling the half-orc "son of the Mak". Last you saw him he was being carted off to a temple for healing.

Rumors: A number of caravans and patrols have been attacked west of the city, usually those heading for the Gnarley or the Wild Coast. These attacks always targeted the lightly-defended caravans. People speak of an informant inside the City, perhaps even the Oligarchy.



THIEVES' GUILD

Mission: You were walking down the street, when a known informer called you aside. "There's a job for you. Be at the Black Dragon Inn after nightfall. Your services can definitely be used. Be there." Looking around, the informer quickly leaves you, vanishing in the crowd.

Rumors: A number of caravans and patrols have been attacked west of the city, usually those heading for the Gnarley or the Wild Coast. These attacks always targeted the lightly-defended caravans. Someone is leaking information to bandits since bandits in the western plain have been rather successful. There is little doubt that this informer hails from Greyhawk. Fellow guild members whisper about a possible informant within the guild.



CHURCH OF ST CUTHBERT

Mission: You have been called by one of the deacons, Brother Jonas. Sitting you in a quiet office, he explained to you that a chalice of great value was stolen in a convoy heading for Safeton about a week ago. The Chalice is said to have been touched by St. Cuthbert Himself when he walked the Flanaess. Though it is non-magical, it has great value to the church.

Brother Jonas explained to you that he had wind of someone who was planning to send a group of adventurers against the person responsible. He asked you to be at the Black Dragon Inn shortly after nightfall.

Rumors: A number of caravans and patrols have been attacked west of the city, usually those heading for the Gnarley or the Wild Coast. These attacks always targeted the lightly-defended caravans. People speak of an informant inside the City, perhaps even the Oligarchy.



NIGHTWATCH

Mission: One of the sergeants stopped you as you had just entered Greyhawk. "I was going to a meeting, but have been called outside of town on a personal matter. Anyway, head to the Black Dragon Inn. There is a man who is looking for people there. Be there just after sun down."

Rumors: A number of caravans and patrols have been attacked west of the city, usually those heading for the Gnarley or the Wild Coast. These attacks always targeted the lightly-defended caravans. People speak of an informant inside the City, perhaps even the Oligarchy.



THIEVES GUILDS FROM COUNTRIES AROUND THE NYR DYV

Mission: You have been asked by your guild superiors to travel to Greyhawk City. Apparently, the Greyhawk boys need some help and your guild is willing to help. You are expecting to meet someone at the Black Dragon Inn tonight, just after sun down.



Greyhawk City Puzzle

By Colleen Simpson

What do the deaths of a wizard's daughter and a priestess's favored servant have to do with an invitation to the Foreign Quarter? Once again, the City of Greyhawk is host to yet another deadly puzzle and you've been drawn right into the middle. Can you find the connection?. This is an investigation that still has some use for fighters. A one-round Core adventure set in the City of Greyhawk for characters level 1-10 (APLs 2-8).

Resources for this adventure [and the authors of those works] include CGR7-01: *Death in the Free City* [Creighton Broadhurst and Chris Chesher] and CGR7-02:1 *Into the Silent Barracks* [Creighton Broadhurst].

ADVENTURE BACKGROUND

When the Matriarch of St. Cuthbert, Eritai Kaan-Ipziral, dispatched her servant Korenth to investigate the reason behind the rise in banditry plaguing Greyhawk City and its environs, she did not foresee that he would end up dead. When Gamboral's daughter went adventuring, she didn't count on ending up dead either. But, there you have it, both died.

These events have upset Gamboral and Eritai very much, and they have been striving to find out what happened to their deceased servants and loved ones. Meanwhile the repercussions of Turrosh Mak's ground-breaking overtures, rumble on in the background.

Others have been watching their search and the political developments with interest, and have seen an opportunity to throw the Matriarch's investigations and the search of a grieving father off the trail – while putting paid to the Mak's plans for peace. They only had to lay the bait...

ADVENTURE SUMMARY

Introduction: PCs receive an invitation to a 'private party' at one of the more up-market boutiques in the Foreign Quarter, as well as a request to go and see Gamboral and Eritai Kaan-Ipzirel. They need to decide who to visit next. Their faction missions provide hints that Korenth's killer, or those involved in the death of Gamboral's daughter, might have links in this quarter.

Encounter 1A: PCs are shown into an upper room where they meet with a woman who is a city actor pretending to be a priestess of Iuz in disguise. There is a chance that they realize that she is, in fact, an actor, but the information they receive from her is the same. The symbol of Iuz she carries is genuine. She cannot say who

hired her, just that she is being paid a good amount for the information she carries. If the PCs refuse to assist her, the symbol she carries is triggered and combat with shadow creatures ensues. If they agree, they are later attacked on their way to their next location by shadow creatures – Encounter 2A.

Encounter 1B: Gamboral has been under observation ever since his daughter's body was found in the ruins. He says that his research suggests that the same person that killed Korenth, was also responsible for the murder of his daughter. He asks the PCs for help, but doesn't have any real information to give.

Encounter 1C: Eritai has divined that the ones responsible for Korenth's death are in the city (true, but only to set up the actor and the thugs and to observe proceedings from there). She, too, is under observation.

Encounter 1D: PCs may choose to look for clues in the Royal Theater, but this is a dead end and they are met by a messenger from Eritai Kaan-Ipzirel to help them get back on track.

Encounter 2A: If PCs agree to help the actress, they have been positively identified as 'trouble' and are attacked. A rogue, that has been following them, throws a brooch down at their feet, activating a spell that releases shadow creatures.

Encounter 2B: PCs encounter two street urchins, who have been instructed to release the contents of a *bag of holding* in front of them. Emptying the bag releases ogre/s into the street, which return to their full-size and attack the PCs. The ogres are wearing tunics bearing the medusa-head device of the Pomarj, indicating that Turrosh Mak has broken the treaty. Once the creatures have been defeated, PCs may question the urchins and discover the room rented by the agent of Iuz. They may also learn that the *bag of holding* was obtained from the wizard Palfrey.

Encounter 3A: PCs follow the urchins to the rooms (or go in pursuit) of the elven wizard that set them up with the ogres-in-the-bag trick.

Encounter 3B: The PCs arrive at dusk to find the wizard's house open and apparently unoccupied. From the crashes inside, something is not right. Inside, they encounter the wizard (who is obviously in bad shape) and an imp (busy ransacking the place). The wizard was given the impression (via *suggestion*) that the imp had brought him payment in the form of a rare bottle of wine for work done. (It was, in actual fact, a dire poison as he discovered when he drank it.) The imp must be driven off or killed so that the PCs can find treatment for the wizard. If they save him, they discover he created the bag and sold it to a half-orc boy on an errand from his master. If they do not save him, this information remains a mystery, unless they investigate his ledgers and journal, or use *speak with dead*.

Encounter 4: PCs are attacked by slavers who have been paid a bounty for them. Clues indicating Mak. Another clue leads to the slavers' HQ.

Encounter 5: PCs investigating the slavers' HQ discover more slavers – who need to be defeated before clues can be uncovered. Clues that the Mak is not involved include a contract that was signed in the same hand inviting PCs to the foreign quarter, directions to include half-orc/disguised orc members to capture PCs, and the fact that the slavers are a bit puzzled as to why they had to wear uniforms that would tie them to the Mak's forces.

Conclusion: At the end of this, PCs have found no clues regarding either Korenth's or Etrezza's death but they have discovered that someone is trying to cause trouble for Turrosh Mak and the peace deal in the form of a note with the Mak's initials on it (that matches another note not written by him) and a chore list by a wizard that has obtaining uniforms from the Mak's forces as a 'to do' item.

PREPARATION FOR PLAY

Affiliation Briefing Sheets

Many of the PCs participating in this adventure will be members of one of the free city's affiliations (as detailed in the *Greyhawk Ruins Sourcebook*). Before play begins, hand out the relevant briefing sheet to each player. PCs not belonging to any affiliation must determine for themselves why they are exploring the ruins.

Favors

Note which PCs have the following favors:

- **Thanks of the Family Gamboral:** from CGR7-02:1 *Into the Silent Barracks*. PCs with this favor, may wish to utilize it this adventure. They are also approached by a messenger from the family, to look into the rumors that link Etrezza's death with that of Korenth.

ERRATA

The *alternate form* text for an imp should read as follows: An imp can assume another form at will as a standard

action. Each imp can assume one or two forms from the following list: Small or Medium monstrous spider, raven, rat, and boar.

INTRODUCTION

The PCs receive an invitation to a 'private party' at one of the more up-market boutiques in the Foreign Quarter, as well as a request to go and see Gamboral and Eritai Kaan-Ipzirel. They need to decide who to visit next. Their faction missions provide hints that Korenth's killer, or those involved in the death of Gamboral's daughter may have friends in this quarter.

You've been in the city long enough to give your weapons into the guards' keeping, and to find a place to stay, before departing on private errands of your own. For some of you that involves visiting the organisation/s you belong to, and for others it involves spending some time down in the High (and Low) Markets or the theatre. Along the way, you notice that you have some friends in town.

Give the PCs time to introduce themselves to each other and decide if they know each other. Give those players belonging to affiliations, their Affiliation Briefing Sheets, and allow them time to read and absorb what's there. Allow PCs to make any purchases from the markets and then read:

Returning from your meetings, you arrive to find a gilt-edged invitation propped up on the night-stand of your quarters. How the note came to be here, or who delivered it, is something no-one appears to know. The words are scribed in a rich purple ink, the paper is edged in gold, and the soft perfume of Myst-Lake liliams greets your nostrils.

Give PCs time to respond and hand out Player Handout 1. When they are ready, find out what they want to do next. They have a number of options they could follow at this point.

If PCs decide to answer the invitation to the foreign quarter, proceed to Encounter 1A.

If they decide to visit the Wizard Gamboral, proceed to Encounter 1B.

If they decide to visit the Matriarch Eritai Kaan-Ipzerial, proceed to Encounter 1C.

1A: ANSWERING THE FOREIGN QUARTER INVITATION

PCs are shown into an upper room where they meet with a woman who is an actor pretending to be a priestess of Iuz in disguise.

There is a chance that they realize that she is, in fact, an actor, but the information they receive from her is the same. The symbol of Iuz she carries is genuine. She cannot say who hired her, just that she is being paid a good amount for the information she carries.

As the PCs arrive at the resting house with their invitations, read:

The Golden Horseshoe Resting House is one of the older establishments in the foreign quarter. It stands three-storied tall, and is surrounded by a wall. A carriageway allows guests to be dropped off and picked up from the covered portico that marks the Horseshoe's entrance, and iron gates guard the entrance where guests stable their horses. The doorman eyes you warily, but lets you enter the foyer of this upmarket inn.

A broad, wooden counter, gleaming with polish and gold trim stands before the wall on your left. Ostentatious doors lead into an eating area that wouldn't be out of place in a nobleman's mansion.

"May I help you?" an imperious voice asks.

Give the PCs time to respond. If they look toward the counter, read:

The man behind the counter is dressed in somber gray with a silver trim. His light blue eyes are alert, even though his face expresses nothing more than the gentle concern any good host would show a guest. Black hair going gray at the edges gives him a distinguished air.

"May I help you?" he asks again.

This is Terry. He does not allow them any further into the Resting House unless they show him their invitations. He calls the Watch (who respond promptly) if they insist on entering by force. Once the PCs show him the invitation, read:

The man's mouth relaxes into a broad smile, and the edges of his eyes crinkle with relief. "So there are some good folk in the world after all," he grins. "Follow me, I will take you to her."

Terry is under the impression that the lady is in trouble and has sought the PCs' assistance on a matter of urgency. He does not reveal this to the PCs unless he becomes the subject of a *charm person*, although he makes it clear that he is glad there are still some noble hearts in the world. Read:

Terry knocks twice, pauses, and then knocks twice again.

"Send them in." The voice that responds is gentle and full of melancholy.

Terry raises his eyebrows to you, and swings open the door, indicating that you should enter. He waits, hand extended in an 'after-you' gesture.

Looking in, you see a long room, in which is centered a round, well-polished table surrounded by upholstered chairs. At one end of the table, sits a cloaked woman. Her make-up has run as though from tears, and her eyes are huge with worry. "Please," she says, "won't you come in?"

The light of a single candelabra standing in the middle of the table illuminates her face, sending golden shadows chasing across it. The only other light in the room, comes from candles mounted along the walls. Heavy drapes cover what must be windows.

Terry closes the door as soon as the last PC has entered the room. He does not lock it, and he does not linger in the hallway, but returns immediately to his post at the front desk.

☛ Terry: male human expert (innkeeper) 6

When the door has closed and the PCs have settled, read:

"Ladies, gentlemen. I am glad you came," she begins. I have come to the City in disguise because my kind are reviled across the Flanaess. Even you, noble-hearted ones, would not have agreed to help me, if you had known my true identity."

She holds up a hand, stalling any interruption and reaches to the leather cord visible around her throat. Lifting it carefully above her head, she places it, and the skull symbol dangling beneath it, and lays it on the table.

"Please," she says, "hear me out. I have come to ask a favor. It will not harm your beloved Greyhawk, but will keep it safe."

PCs may wish to respond at this point by making a number of skill checks:

- A DC 13 Knowledge (religion) reveals that this is the symbol of Iuz, demigod of Deceit, Pain, Oppression, and Evil.
- A DC 15 Appraise check reveals that the symbol is real, or, if not real, a very expensive fake.
- Make an opposed Sense Motive check against Greta's Bluff check. PCs succeeding at the Sense Motive check, sense that there is something Greta isn't telling them, and can press her for more details. If they press too hard, however, they trigger the attack of the shadow creatures.
- PCs succeeding at a Spot check opposed by Greta's Disguise check realize that this woman does not seem to be marked by the cruelty that one would expect from a follower of Iuz. They can challenge her identity, if they wish, but this triggers the attack of the shadow creatures.

Alternatively, they may wish to cast a number of spells to determine more:

Detect Evil: 1st round: evil is present. She is tainted by it, and so is the symbol of Iuz; 2nd round: There are two

evil auras present, the strongest of which belongs to the symbol of Iuz; 3rd round: Greta is surrounded by a very weak and dim aura of evil – as though she has recently associated with someone, or something evil, but is not evil herself. The symbol of Iuz has a strong aura of evil.

Detect Magic: 1st round: That she is surrounded by magical auras – as is the symbol of Iuz; 2nd round: That there are five magical auras on or near her person, and that the strongest one rests on the holy symbol she has placed on the table; 3rd round: That the auras can be identified as follows:

- DC 18 Spot check reveals magical aura under the front of her robe. This aura is one of faint transmutation, about the size of a thumb (*amulet of natural armor*)
- Cloak (dark blue with silver trim) has an aura of moderate transmutation (*cloak of Charisma*)
- Vest (white, edged in silver piping with silver buttons – hidden under robe) DC 12 Spot check to notice glow of moderate abjuration.
- Symbol of Iuz: has a strong aura of evocation.

TALKING WITH GRETA

If the PCs do not attack, but instead talks with Greta, she visibly relaxes and begins to speak her lines. (If any of the PCs express doubt, allow a Sense Motive check at any of the points marked with **). Read:

*The woman before you visibly relaxes. "I'm so glad you will listen. While my master is no friend of Greyhawk City, he does not wish to see the Mak rise to power. That 'creature'," she almost spits the word, "is not to be allowed to garner greater power.**"*

Greta has learned these lines well, but the PCs can still see through her act.

*"He works to lull the City into a false sense of security, while he works on different methods of smuggling his creatures inside to ferret out all its weaknesses. He seeks the City's fall.**"*

Greta has learned these lines well, but cannot bring herself to believe them, so there is an undercurrent that lacks conviction in her tone. PCs might hear skepticism in her tone, and wish to question her more closely.

*She pauses, drama etched in her very pose.***

Greta's pose is a little too dramatic. PCs succeeding at an opposed Sense Motive check are reminded of a night out at the theater and a certain actress who plays the 'girl who cried wolf' in a recent theatrical hit.

*"And my master wishes to know that it was the Mak who was involved in Korenth's death, and the Mak who controlled the men who saw that Gamboral's daughter died.**"*

PCs that win an opposed Sense Motive check are reminded that they only received their instructions this morning. It suddenly strikes them that the Mak would make a very convenient patsy for anyone wanting to disrupt the peace process, and they can think of a number of factions who stand opposed. (Greta has no evidence to back up her claims and tries to argue that the Mak's involvement in these deaths is logical – even though he appears to be trying to broker a deal. If a PC brings up that the Mak, even if he was trying to pull the wool over Greyhawk's eyes, wouldn't be dumb enough to murder a servant of the Matriarch of St. Cuthbert until he'd achieved his goal, she has no response and her arguments peter out. At this point, the shadow creatures attack.)

*"I will be staying here for the next ten day, trying to find out what connections I can. Promise you will send a report to me via Terry, each evening as the sun sets?***"*

A successful opposed Sense Motive checks reveal nothing but the truth, at this point. If the PCs ask for a reward, read:

"A reward?!" the woman gives a short bark of laughter. "I thought you hated my kind? Wouldn't deal with evil..."

Very well. My master's resources are wide and varied. I will present him your request in my nightly prayers, and see what answer he provides. Come and see me tomorrow evening, and we will finalize this deal."

The PCs leave, having agreed, read:

With a little smile, and a wink, the woman picks up the symbol of Iuz and slips it over her head. She watches you leave from her vantage point from behind the table.

While it seems unusual for a priestess of Iuz to be involved in something like this, it's not entirely out of the question.

Greta Mayani

Female human bard 6 (Bluff +12, Disguise +9, Perform (act) +16); see Appendix 1 for more details.

Attitude: Friendly (PH 72) if rescued; indifferent: if rescued but going to be turned over to the Watch; Helpful: if rescued and PCs agree not to turn her over to the Watch.

What Greta Knows: Greta knows nothing of the deaths of Korenth and Etrissa – save what is already common knowledge, and she does feel sorry for Etrissa's family, and sympathy for Eritai having lost a servant that she was more a colleague and a friend.

Greta tells the PCs she was hired by an elven man, who paid her well (no, she does not disclose the amount – that's private, and not something professionals share) to play the part of a priestess of Iuz and give the PCs the information she has brought.

She, personally, does not know what to think of the peace treaty and the Mak, nor does she really care. She'd be happy to see it go ahead, as long as it means that there will be less tension in the region.

She doesn't think much on Iuz. She's never run afoul of his priests, and shivers if the PCs point out that, having agreed to impersonate one, his priests probably know about her. The thought makes all color drain from her face, and adds an urgency to her request for them not to report her to the Watch – after all, anything that goes on in the Watch house soon comes back to the streets and the priests of Iuz would find out for sure then.

SHADOW ATTACK

If the PCs move to attack Greta, their actions trigger the shadow creatures' attack, read:

Even as you act, a sudden, sharp gust of wind swirls through the room, putting out the lamps along the walls, and causing the candles to gutter out. When it is gone, only three candles remain, lighting the centre of the room and leaving dancing shadows to populate the corner of the room.

Is it our imagination, or are some of those shadows growing thicker and taking form. And was that a growl?

All APLs (EL 6)

☛ **Greta Mayani:** female elf bard 6; hp 21; Appendix 1.

APL 2 (EL 3)

☛ **Shadow Krenshar (1):** 11 hp; Appendix 1.

APL 4 (EL 5)

☛ **Advanced Shadow Krenshar (1):** 57 hp; Appendix 1.

APL 6 (EL 7)

☛ **Advanced Half-Fiendish Shadow Krenshar (1):** 65 hp; Appendix 1.

APL 8 (EL 9)

☛ **Advanced Half-Fiendish Shadow Krenshar (2):** 65 hp each; Appendix 1.

NOTE: The EL has been calculated at +1 because the laws of Greyhawk prevent the PCs from carrying their normal array of weapons and employing greatly destructive combat techniques... or they should.

Tactics: Use these notes to run the battle:

Greta: She tries to put something (a PC, table, chair, anything!) between herself and the krenshar/s. She has no offensive spells. If the PCs don't attack her, she uses her *inspire courage* ability to assist them.

Shadow Krenshar: The krenshar(s) uses its *shadow blend* ability to maximum effect at all APLs. When on its own, it focuses on the PC that poses the most obvious threat (choosing the fighter, currently hitting it, over

spellcasters or others using ranged attacks). Where there is more than one krenshar, they use pack hunting tactics such as flanking.

NOTE: At APLs 4 and above, the shadow krenshar is a large creature is forced to squeeze.

AREA FEATURES

Ceiling: The ceiling in this room is ten feet high.

Lighting: The lanterns provided enough light, but shadows lingered in the corners of the room. Once the lanterns blew out, PCs find themselves suffering the effects of shadowy illumination (PH 164-165).

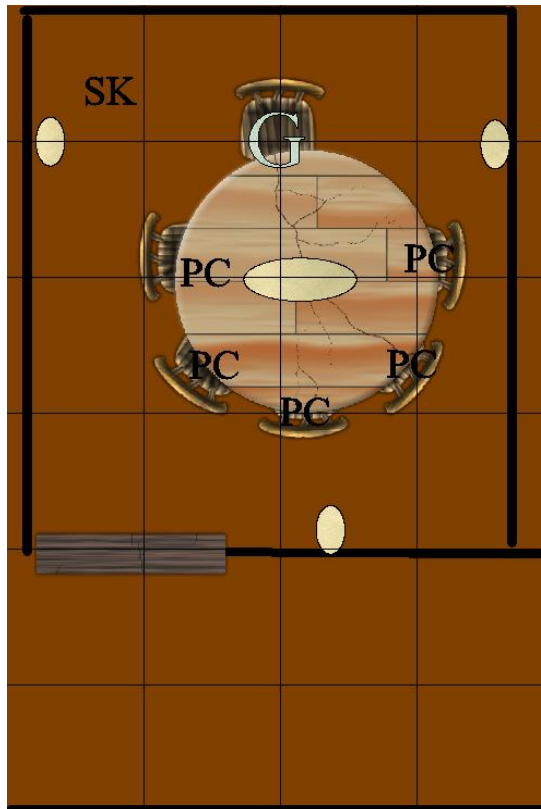

DEVELOPMENT

Questioning Greta: Once the PCs have defeated the shadow creature/s, and if they have managed to keep Greta alive, they may ask her more questions.

Who are you, really? I'm Greta Mayani, a performer at the Royal Opera House.

Why are you masquerading as a priestess of Iuz?

It was just another role – you know, pretend to be someone else, make the audience believe your story, and get paid. Actors take parts where they can find them... and I didn't see that it was doing any harm...

Who hired you? I don't know. He was elvish, though – very handsome. Wore that lovely chainmail they're known for and carried a finely crafted longsword. I couldn't tell if he was a wizard or a warrior; you get all sorts visiting the theater!

Stay right here; we're calling the City Watch: Please don't. I promise I won't do anything so stupid again. I'll pay you for rescuing me; I'm not impoverished, you know... and I know people. Not dobbing me in could bring its own rewards. I could make arrangements... (If any PC makes an improper suggestion: No! Not that kind of arrangement! The other kind, where I help you find what you want... oh, that didn't come out right either! You know what I mean! Now, no more suggestions like that, or I'll call the Watch myself!)

Greta really doesn't know much more than that. She's been well paid for her masquerade, and is in deep shock, that her employers would put her at risk of attack by the terrible monsters summoned by the symbol. She is in shock and clings to any PC who offers her support and sympathy – particularly any male warrior who put himself at risk to get between her and the shadow creature. She's grateful to female PCs as well, but doesn't cling to them – after all, if a girl can be a strong warrior, then she can be a brave bard!

She asks for an escort back to her quarters not far from the Opera House, offering to pay PCs 10 gp to get her home safely. She is strongly opposed to seeing the Watch, but won't run away or resist if PCs insist on taking her to see them.

Turning Greta over to the Watch: After questioning her, PCs may turn Greta over to the City Watch. The Night Watch station is open and she is charged and placed in a cell. PCs are asked for statements, and told not to leave town before the trial. They are then free to continue on their way.

PCs who rescue Greta, but do not turn her over to the Watch, receive the 'Gratitude of a City Bard' AR Award.

PCs who rescue Greta, but do turn her over the Watch, receive the 'Owed a Bard's Debt' AR Award.

If there is dissension on whether or not to turn Greta over to the authorities, have the players vote on the course of action taken.

Shadow Creatures Attack: If PCs have been attacked by the shadow creatures, skip Encounter 2A; they are not attacked again. Allow them to progress to the next stage of their investigations.

Go to the Royal Opera: PCs may wish to go to the Royal Opera House to learn more. If they do, go to Encounter 2C.

Agreeing to help Greta: If PCs agreed to help Greta's priestess persona, go to Encounter 2C.

1B: VISITING GAMBORAL

Gamboral has been under observation ever since his daughter, Etrezza's, body was found in the ruins. He says that his research suggests that the same person that killed Korenth, was also responsible for the murder of his daughter. He asks the PCs for help, but doesn't have any real information to give.

"Yes?" The middle-aged wizard looks out his door at you. It is easy to see the grief that lines his face, and hangs, like a shroud, over his every move. He might once have been one of the top magic-workers in the guild, but he doesn't look like it now. His daughter's death seems to be sapping him of his strength. "How can I help you?"

If the PCs explain that they have come to help investigate his daughter, Etrezza's, death, read:

Moisture wells in the man's eyes, and emotion colors his face. "Come in. Come in," he says, stepping aside. "There isn't much I can tell you, but what I know I will.

Allow the PCs to settle themselves. He then begins:

You see, a week ago, I sought out a diviner and asked him to look into my daughter's death. He mentioned K...Korenth in his divining and for a moment, I couldn't think of who the man might be. I am ashamed to say that it took me a full day to puzzle out his identity. Oddly enough, he is the only other I could think of, who'd had any real business outside the city. The diviner thinks the deaths are linked in some way, but whether or not it's the same perpetrator, or some other link, he couldn't say."

Allow the PCs to discuss this. When conversation peters out, continue:

It's obvious that this is all he knows. "Please," he says, "I know it's not a lot of information, but see what you can discover about her killers – that would bring some comfort, even if you never find out why."

On this last word, his voice trembles and cracks and he sinks into his chair as sobs tear themselves free of his chest. Unbidden, a man emerges from deeper in the house. Frowning at his master and glaring at you, he indicates the front door.

"Come back another time," he says, 'when you have answers for my master. He needs to rest now."

The look on his face commands you not to argue, and you can see the silent plea that you will leave and not cause his master any more distress.

Hopefully, the PCs leave without forcing the manservant's hand. If they hesitate he says, "I ask that you come back when my master is not so distressed. Please leave now."

GAMBORAL

Attitude: Friendly (PH 72) or helpful (to those with the Thanks of the Family Gamboral AR award).

What Gamboral Knows: Gamboral knows that he misses his daughter terribly, and that her death has left a terrible in both his heart, and his wife's heart. He feels that some of the pain they feel will be reduced by

knowing the why of her death, and that is why he paid for the divinations. He knows that Etressa's death, and that of Korenth, are inextricably linked, but he cannot identify the link. He wants whoever committed the murders stopped – forever. He also knows that Matron Eritai Kaan-Ipzeriel believes the same thing, but does not know if she has any other details that she is withholding from him. Perhaps the PCs could speak with her?

◆ **Gamboral:** male human wizard 8.

CURREL

Attitude: Indifferent (PH 72) or friendly (to those PCs who have the Thanks of the Family Gamboral AR item)

What Currel Knows: He knows that his master believes Etressa's death is linked to that of Korenth and, after hearing the divination, he is inclined to believe the same. He also knows that the house is not the same without Etressa around, and remembers times when anticipation of Etressa returning home to visit would fill the house with joy. It is obvious that he adored Etressa – in much the same way a brother would adore his adventuring sister.

◆ **Currel:** male human expert (butler/valet) 4.

DEVELOPMENT

The PCs are free to continue with their investigations. There is no more information to be found here.

1C: VISITING ERITAI KAAAN– IPZIEREL

Eritai has divined that the ones responsible for Korenth's death are in the city (true, but only to set up the actor and the thugs and to observe proceedings from there). She, too, is under observation.

The faith of St. Cuthbert is the most powerful church in the city. As the PCs approach, read:

In front of the church is a wide courtyard, paved in white tiles. Pathways lead through well-kept gardens of roses and other exotic plants to a large, circular fountain. In the center of the fountain stands a statue of St. Cuthbert himself. As you approach, a human male, clad in simple brown robes, adorned by the symbol of an oaken cudgel rises from his knees and steps towards you, a large, white dog at his heels.

"The Matriarch is expecting your visit," he says, "but she cannot add much to what you already know."

He leads you through large double doors bound in ornate brass scrollwork into the temple.

PCs are led through to see the matriarch. Continue:

After traversing the holy halls of this great temple, you are led into a sitting room. Large windows look out over the temple gardens, and a woman, dressed

in the brown robes of St. Cuthbert stands before them, observing the scene outside.

When she turns, you notice the aura of authority that hangs over her like a cloak and know, beyond doubt, that you stand in the presence of one of St. Cuthbert's chosen.

"I know why you are here," she says, "and I can only confirm what the divinations have said. That a common factor links the death of Korenth and Etressa, and that the trail began outside the city. That this danger is now within Greyhawk's walls, is beyond doubt, but where it resides, and what form it will take, I do not know."

She turns away from you, then, and looks out across the gardens once again. Berronn seems to take it as a sign of dismissal, and begins to usher you towards the door.

BERRON

Attitude: Friendly (PH 72) or helpful (towards fellow believers).

What Berron Knows: Berron knows that Eritai believes that the deaths of Korenth and Etressa are linked to each other and to the ruins. He knows she believes Iuz has plans in motion. He does not know what her thoughts are on the Mak and the peace plans and any relation they might have to the current happenings. He knows that Eritai has recognized that the PCs will help with these matters and wants to meet with them, in order to 'get a feel for them'

Berron: LN Male human cleric (St. Cuthbert) 6.

ERITAI KA'AN–IPZERIEL

Attitude: Friendly (PH 72) or helpful (towards fellow believers). Eritai has followed the PCs' progress and knows they can help sort fact from fiction.

What Eritai Knows: Eritai believes, from her divinations, that the deaths of Korenth and Etressa are connected, both to each other, and to the other things happening in the Free City. She believes that the PCs are part of the puzzle, a helpful part, and that they can help sort fact from fiction. Eritai, also thinks that Korenth's death has something to do with the happenings in the ruins, and that Iuz is somehow connected to it all. She cannot yet discern how Turrosh Mak and the peace plans are linked to the muddle, but she does believe they are.

◆ **EritaiKaan-Ipzeriel:** female human cleric (St. Cuthbert) 14.

DEVELOPMENT

The temple of St. Cuthbert is being observed, and visitors are noted. Visitors who also saw Gamboral, or went to the Foreign Quarter, or those that are believed to have anything to do with the investigations into Korenth's and Etressa's deaths are especially marked. Once the PCs leave the temple, plans are set in motion for the next phase of Iuz's plan to upset the peace process. Go to Encounter 2B.

2A: AMBUSH IN THE FOREIGN QUARTER

PCs have refused to help the 'priestess of Iuz' persona played by Greta Mayani. Read:

Leaving a disappointed priestess of Iuz with your refusal, you close the door behind you. As it clicks shut, you hear a startled scream.

"Help me!" the priestess shrieks, and there is real terror in her voice.

"Help me!" The cry comes again, and doors up and down the hallway open in response. Curious guests peer out at you as another scream, wordless this time, rips through the air.

Let the PCs respond. If they turn back into the room, read:

As you fling open the door, you note that the room is almost completely dark. The lamps lining the walls have gone out, leaving only the candelabra to provide light – and even the flames of its candles are threatening to go out.

The priestess is cowering in a corner, holding a chair before her as one of the very shadows bites great chunks out of it. As dark jaws crunch down to splinter another chair leg, she screams again, and almost drops the chair.

Go to initiative. Unless the PCs do something to attract its/their attention, the shadow beasts have another go at the chair. In this round, they will be successful in taking it from her hands.

All APLs (EL 6)

☛ Greta Mayani: female elf bard 6; hp 21; Appendix 1.

APL 2 (EL 3)

☛ Shadow Krenshar (1): 11 hp; Appendix 1.

APL 4 (EL 5)

☛ Advanced Shadow Krenshar (1): 57 hp; Appendix 1.

APL 6 (EL 7)

☛ Advanced Half-Fiendish Shadow Krenshar (1): 65 hp; Appendix 1.

APL 8 (EL 9)

☛ Advanced Half-Fiendish Shadow Krenshar (2): 65 hp each; Appendix 1.

Tactics: Use these notes to run the battle:

Greta: She tries to put something (a PC, table, chair, anything!) between herself and the krenshar/s. She has

no offensive spells. If the PCs don't attack her, she uses her *inspire courage* ability to assist them.

Shadow Krenshar: The krenshar(s) uses its *shadow blend* ability to maximum effect at all APLs. When on its own, it focuses on the PC that poses the most obvious threat (choosing the fighter, currently hitting it, over spellcasters or others using ranged attacks). Where there is more than one krenshar, they use pack hunting tactics such as flanking.

NOTE: At APLs 4 and above, the shadow krenshar is a Large creature is forced to squeeze.

AREA FEATURES

Shadowy Illumination: The room is in near darkness, with the candelabra providing shadowy illumination.



DEVELOPMENT

Greta is very grateful, if she is rescued by the PCs, but begs them not to report her to the Watch. She admits that she is not a priestess of Iuz, but was well-paid to play the part. If the PCs report her to the Watch, she is disappointed, but acknowledges that she owes them a debt for saving her life. Any requests for updates on the investigation receive the reply that "Investigations are still ongoing." Use the roleplaying notes in Encoutner 1A to facilitate the PCs' discuss with Greta.

2B: OUT OF THE BAG

An agent of Iuz made his way into the city and found a wizard who had a *bag of holding* to spare. Having divined where to find some of Turrosh Mak's ogre forces, he then *charmed* the ogres into trusting him enough to be paid for a job in Greyhawk City. In order to smuggle the creatures into the city, he supplied them with *iridescent ioun* stones (enabling them to survive in an environment without

air), convinced them (via his *charm*) that the *bags of holding* were a safe way of entering the city (and exiting it, once the job was done). All they had to do was attack and kill the adventurers they saw when released.

He then used *reduce person* to fit them into the *bags* safely and followed it with *permanency* to make sure they didn't enlarge before time.

Entering the city with his now undetectable ogres, he rented a room near where he had divined the adventurers would pass, and hired the urchins to take and turn the bags inside out in front of the party. He is watching from a second-floor window when the urchins release the ogres, ready to *dispel* the *permanency* and return the ogres to their original size. Read:

The city of Greyhawk hums around you, filled with all the bustle and hurry you have come to expect.

There are the horse carts taking goods to and from warehouses, and people hurrying about their business. There's even a pair of urchins fleeing out the doorway of a nearby inn, mischievous grins on their faces and a bag in their hands.

They dodge around a fat merchantman dressed in clothes from a colder climate, skip past a noblewoman and her frowning escort, and crouch down a bare five feet from you.

They turn their bag/s inside out, dropping two figures to the cobbles, as well as two blocks of wood.

PCs making a DC 35 Spot check notice something strange about the second floor window of the nearby inn.

Allow PCs that win initiative, to respond before the *reduce person* is *dispelled* and the ogres return to their normal size. If the PCs lose initiative, or choose to wait and see what happens, read:

The figures get to their feet, picking up the clubs that have fallen beside them. At the same time, they begin to grow in size, growing from four-and-a-half feet in height to a full nine feet of wart-covered, greasy-haired stench. Hefting clubs that have enlarged with them, they ignore the children scrabbling back away from them, and the startled outcry being raised by passers-by. Their tunics are emblazoned with the symbol of a fierce-haired medusa. As their little, red eyes fasten on you, they attack.

On their turn, PCs may wish to make one or more of the following checks:

Bardic Knowledge: A DC 10 check reveals that ogres formed a good part of Turrosh Mak's forces in recent attacks on the Wild Coast.

Knowledge (local – Core) A DC 20 check recognize the symbol on the creatures' tunics as that commonly worn by troops belonging to Turrosh Mak.

Knowledge (nature) A DC 14 check recognizes these creatures as ogres.

Spot: PCs making a DC 15 check notice that each ogre has a small stone circling its head as it comes out of the bag, but that these stones vanish with a flash as the creatures rise to their feet.

Sense Motive: On the urchins before the ogres appear: DC 10 check reveals that the urchins are excited about what they are doing, while DC 13 reveals no maliciousness in their actions. On the urchins after the ogres appear: A DC 5 check reveals pure terror at the sight of the ogres.

Spellcraft on the ogres: (Only if PC has *detected magic* on ogres). A DC 24 check reveals that the ogres are under the effects of a *charm monster* spell.

Spellcraft on the stones (only if PC had *detect magic* running when the ogres emerged). A DC 21 check reveals moderate transmutation magic.

Spellcraft on the bags (if PC has *detect magic* running and time to investigate) a DC 20 check reveals moderate conjuration magic.

ALL APLs

☛ **Agent of Iuz:** *invisible*; Initiative +6; Concentration +2I

☛ **Sameus:** female half-elf child; Initiative +1; Hide +4

☛ **Moly:** male human child; Initiative +1; Hide +4

APL 2 (EL 4)

☛ **Ogre (1):** hp 29; MM 199.

APL 4 (EL 6)

☛ **Ogre (2):** hp 29 each; MM 199.

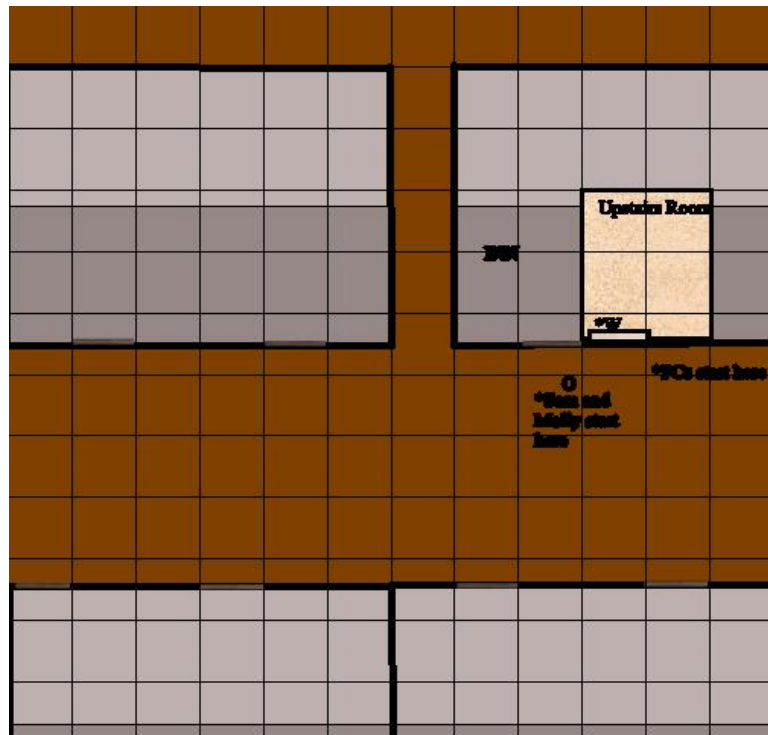

APL 6 (EL 8)

👉 **Ogre Barbarian (1):** hp 79; MM 199.

APL 8 (EL 10)

👉 **Ogre Barbarian (2):** hp 79 each; MM 199.

Agent of Iuz Tactics: *Dispels the permanency on the reduce person in the first round; teleports himself out of Greyhawk in the second round.*

Street Urchin Tactics: Moly and Sameus are horrified when the ogre/s appear. They drop the *bag of holding*, and dive into the shelter of the nearest alley, burrowing under piles of refuse, or hiding behind boxes to avoid being seen. When they realize that the ogre/s aren't looking for them, they watch the ensuing fight from around the corner of the alley.

Ogre/s Tactics: The ogres have one tactic – kill! They do not coordinate their attacks, and tend to hit whatever thing hit them last (or is standing in front of them at the time). The ogres do not use ranged attacks in this combat.

Passers-By Tactics: Clear the street and alert the Watch.

The Watch: Arrives in 10 rounds.

Treasure: The following treasure can be gained from this encounter:

All APLs: *bag of holding type I.*

AREA FEATURES

The street is open and cobbled. Passers-by rapidly disappear out of it, and doors and windows on the ground floor are soon shut. PCs have an open street to play in, but nothing they can use for cover.

DEVELOPMENTS

PCs may wish to question the street urchins. The two children know the following:

Sameus

Attitude: Indifferent (PH 72) until assured she isn't in any trouble, then helpful

What Sameus Knows: Sameus knows that they were hired by an elven 'magic man' (Rolls her eyes: "Yeah, that's right, a wizard").

She is angry that he tricked them and vows terrible (but undescribed) vengeance if she ever sees him when she's 'grewed and able to take care of meself. If asked for the last place she saw him, she pales but offers to show the PCs, after ascertaining that they'd be willing to pay her for putting herself in danger – wizards *are* dangerous, dontcha know?

She was paid to empty the bag. How much is none of their business. It's private. She also wants to know if she and Moly can have the bag – after all it was given to them, regardless of what was inside it and the wizard did say she could keep it.

👉 **Sameus:** female half-elf commoner 1.

Moly

Attitude: Indifferent (PH 72) until assured he isn't in any trouble, then helpful

What Moly Knows: Moly knows they're in 'Big Trouble', and it's Sameus that got them into it, not that he'd ever point that out to anyone. Sameus is his friend – his only friend, and they've been getting each other into trouble for years; it was about time for Sameus to have a turn.

Moly is petrified of the wizard, but he's pretty mad at the way they were trick. 'People could have been killed! 'We'd never have done that if we'd known! 'That's evil, and we're not evil.' That wizard is surely in trouble when Moly is bigger, but he's not sure how he's ever going to be able to take him down – I mean, don't wizards start being undead after a while? And aren't undead wizards really hard to kill?

Moly's pretty open to suggestions of being adopted by any guild – except the wizard's guild seeing as he doesn't want to end up undead like all the other wizards (and like many children, he can't yet be convinced that there's any other way for wizards to be. And, of course, he thinks Sameus should be adopted with him, if she has no objections.

He's more than willing to show the adventurers where to find the wizard, as long as they promise to keep him safe until he's ready to take the wizard out.

👉 **Moly:** male human commoner 1.

Following the Urchins: PCs are able to get the location of the elf from the urchins, and can go up to the room where he was staying. Go to Encounter 3A. Divinations do not reveal any clues as to the elf's whereabouts.

Bag of Holding: PCs investigating the *bag of holding*, notice a small maker's mark emblazoned on the base of the bag. A DC 15 Knowledge (local – Core) reveals that this mark belongs to the wizard Palfrey, who is known for his creation of fine magic items. They may wish to go and see what information they can discover from Wizard Palfrey. If they do, go to Encounter 3B.

2C: VISITING THE ROYAL OPERA HOUSE

PCs go to the Royal Opera House to try and discover more about Greta's employer. Their trip reveals nothing, and they must continue their investigations elsewhere. Read:.

It doesn't take you too long to get taken back stage. The stage manager is a very busy person, but, when Greta's name is mentioned you have his complete attention.

"Where is she?" he asks, concern driving his voice up into the higher octaves. He coughs and clears his throat. When he speaks again, his voice sounds almost normal. "Ehem, I mean, where is she? Is she

okay? That fellow she was with – didn't like his look at all, at all."

The PCs are free to question the man from this point onwards. All that he knows about the situation, can be found below:

BASSYL TRUSCOTT

Attitude: Indifferent (PH 72) until PCs mention Greta, then friendly.

What Bassyl Knows: Bassyl knows that he let a wizard backstage, who was looking to hire an actor for a single evening's entertainment. The elf paid him well, and so, he expected that the elf would pay his hireling well also, and since Bassyl gets a cut (how much is none of your business, thank you very much), it was in his interest to show the elf through.

How did he know he was a wizard? Well, that one's easy. He was wearing a robe and carrying a staff, and the spell component's pouch was a dead giveaway. It only takes a minute to note little details like that, you know. With a little cajoling, Bassyl also admits, with a reddened face, that he suspects the elf used a little glamor to make him more cooperative.

He's also worried about Greta. She's the draw-card this evening and he doesn't have time to replace her. She is alright, isn't she? And the PCs can escort her safely to the Opera House, can't they? (On their agreement, Bassyl's attitude improves one level.)

The wizard said nothing about what he planned to next, and Bassyl didn't ask; it's not healthy to ask that sort of thing you know. You do realize that there is such a thing as too much information.

♣ **Bassyl Truscott:** male human bard 8/expert 4.

DEVELOPMENT

PCs will have to pick up the thread of their investigations from here. If they haven't gone to visit Matron Eritai, then they could try that. If they have no intention of going to see her, run Encounter 2B after they leave the Opera House.

3A: TO FIND AN ELVEN WIZARD

PCs follow the urchins to the rooms (or go in pursuit) of the elven wizard that set them up with the ogres-in-the-bag trick.

The inn keeper is horrified as you stalk into the bar, following the two children.

"Oy! You kids! Out of here!" he shouts.

Let the PCs convince him to let them see the room. It doesn't take much – all they have to do is explain the situation, or offer him money... and, of course, they have

to assure him that Sameus and Molyll aren't going to be allowed to get into any trouble.

INNKEEPER TAVICK

Attitude: Unfriendly (PH 72) when PCs enter with urchins; becomes to indifferent when PCs explain situation and friendly when he realizes that the PCs got rid of the ogres.

What Tavick Knows: Tavick knows he rented out the room three nights ago. He's shocked to think that the 'fine elvish gentleman' could be involved in anything so crass as setting ogres loose in the city, and is willing to escort the PCs to the room.

He knows the elvish gentleman in question is currently 'in residence' as he hasn't seen him come down, so he knocks. His horror at the room being unoccupied is more to do with the fact that the room's occupant owes him for the night and was supposed to settle up before he left. Somehow, PCs get the impression that all future guests will be expected to pay cash up front.

♣ **Innkeeper Tavick:** male human expert 7.

THE ROOM

There appears to be nothing in the room to give away the occupant's identity, or who he was working for. The bed is nicely made, and the curtains slightly ajar from where he must have been observing the fight. The bed is unmade, and evidence of the wizard's last meal still sits on a table by the window. The room is surprisingly empty, however, and the innkeeper seems outraged.

A DC 20 Search check reveals a piece of paper that has slipped down between the mattress and the wall. It doesn't seem to have been secreted there, but mislaid. Give the players Player Handout 2.

DEVELOPMENT

PCs may wish to do one, or more, of the following:

- A DC 13 Knowledge (geography) checks identifies the medusa head as the symbol for the Mak's forces.
- Visit the Wizard Palfrey to see what he knows about the *bag of holding*, or to save him from what they could believe to be impending danger (go to Encounter 3B).
- Visit the temple of St. Cuthbert.
- Search for rumors of slavers (no such relevant rumors exist).

3B: OFF TO SEE THE WIZARD

After buying the *bag of holding* from the Wizard Palfrey, Iuz's agent sent his imp to the man, bearing a gift. Palfrey has only just partaken of the gift as the PCs arrive.

It was easy to find out where the Wizard Palfrey lived; he is, after all, well known for the quality of

the items he crafts. The doors to their home are wide open.

As you approach, you hear what might be a strangled cry, and then the crash and tinkle of something falling.

Give the PCs time to react. If they don't go in the front door, they find whatever parts of the house they pass through empty, until they reach the workshop, library, and office. Popular craftsman, he might have been, but the wizard didn't seem to put much stock in luxury. All the wealth in this little house appears to be in this one space.

Finding the workspace is easy – it's located in the central part of the house. It seems that the wizard is a master of at least one craft, and, you note, looking at the tools and leather supplies on one bench, and the large loom that stand along one wall, possibly more.

A bottle of wine stands on the corner of a workbench filled with sheafs of paper, ink stands, quills and books. Of the glass there is no sign.

A DC 12 Spot check reveals the following:

A boot protrudes from around the base of a cabinet that serves as one end of a desk. One of the shoe twitches and a low moan is heard.

Let the PCs decide what to do next. If they investigate, read:

Investigating the protruding boot reveals that there is a foot inside it, and that the foot is attached to what one can assume is the Wizard Palfrey. His face has turned a reddish-purple, as though he is choking, and a shattered wine glass lies beside his body – the blood-red spill of the wine spreading in a pool on the floor.

Before you can go to investigate, however, several books fly off the shelves above his desk, and a small winged humanoid flies off the shelf after them, muttering what might be sibilant curses under its breath.

The curses end in a startled squawk and a low growl as it notices you.

The imp sees the PCs at about the same time as they notice it. Roll initiative as per normal.

All APLs (EL 2)

Imp (1): hp 13; MM 56.

Tactics: The imp's aim is to delay the PCs for as long as possible. Its first action is to become *invisible*, and then position itself for a sting attack on one of the PCs (preferably on one not far from the door, and with no one close by). When visible again, it tries to keep the PCs' attention on itself as it buzzes them and tries not to get

hit. It attacks any PC getting close to Palfrey. If reduced to half its hit points or less, it flees.

AREA FEATURES

Some of the furniture in this area will be an obstacle to the PCs.

PALFREY

Palfrey has been poisoned using dark reaver poison (2d6 Con/1d6 Con + 1d6 Str; DC 18 Fort negates; DMG 297). He has three rounds before he takes secondary damage from the poison, which could kill him.

☞ Palfrey: male human wizard 12; Str 9; Con 5 (usually 14).

DEVELOPMENT

Once the imp is defeated, PCs have the following options:



Save Palfrey (if they reach him before the third round, or if the secondary damage doesn't kill him outright): Measures such as *delay poison*, or using *Heal* to assist him in his next save, may be able to be taken, if the PCs drive off the imp quickly enough, or if they tend to him in spite of the imp. If they manage to speak with him, they can learn what he knows.

To call the Watch and report the death or injury of the Wizard Palfrey: In this case, the Watch gets a still-living Palfrey to the nearest temple for aid. PCs cannot communicate with the wizard to learn anything useful. If he has died, the PCs may organize *speaking with the dead* on the following morning. Depending on what questions they ask him, they may learn something of what he knows.

To Search Palfrey's workshop and home for clues: Looking through ledgers that record what the wizard has bought and sold reveals that the *bag of holding* was the last one he had in stock, and that it was purchased yesterday morning by a 'half orc child – messenger with note from half-orc diplomat located in Foreign Quarter. Money was good. The note has been tucked into the ledger page and

is signed – TM. Comparing the note to the elven wizard's list and/or the invitation reveals that the hand-writing is the same.

NOTE: It is after they report the attack on Palfrey that the slavers strike. Give the PCs time to go to the Watch and/or their various employers, and then run Encounter Four.

4: THE SLAVER ATTACK

PCs are attacked by slavers who have been paid a bounty for them. Clues indicate Turrosh Mak's involvement. Another clue leads to the slavers' base.

This attack occurs after the PCs have reported the ogre attack and any resulting clues to their factions or to the Watch. It occurs after they have regrouped and are heading back to their quarters together. Set up the map, then read:

Filing reports – not your ideal way of ending the day, but the meal at the tavern was good, and your companions have returned from their errands unscathed. Now you're returning to your quarters, walking swiftly through the gathering dusk as the less savory elements of Greyhawk City begin to wake. A sudden movement ahead alerts you to danger.

Let the PCs respond (making Spot checks, readying weapons, and so on), and then read:

A large cat stalks from a nearby alley. It hisses at you, arching its back, and spitting at you, before disappearing back into the alley.

Again, let the PCs respond. Just as things seem more relaxed, continue:

Suddenly more figures wearing tabards emblazoned with a medusa head sigil emerge from the shadowy alley. As they step out of the shadows they draw their weapons.

APL 2 (EL 3)

- ☛ **Hurig:** male half-orc fighter 1; hp 12; Appendix 1.
- ☛ **Nestra:** female half-orc cleric 1; hp 10; Appendix 1

APL 4 (EL 6)

- ☛ **Hurig and Tiama:** male and female half-orc fighter 2; hp 19 each; Appendix 1.
- ☛ **Nestra:** female half-orc cleric 2; hp 15; Appendix 1

APLs 6 & 8 (EL 7)

- ☛ **Hurig and Tiama:** male and female half-orc fighter 3; hp 26 each; Appendix 1.
- ☛ **Nestra:** female half-orc cleric 3; hp 20; Appendix 1

Tactics: The slavers are trying to take the PCs alive. This would usually mean a reduction in EL, but the Greyhawk

City weapons' restrictions even things out. To this end, they take a -4 to their attack rolls to inflict subdual damage. Nestra uses her *charm person* and *bane* spells on the PCs and prepares to cast a *cure* on any that fall. She joins the fighters only if it appears that they might lose.

AREA FEATURES

The alley and street have the following features:

Shadowy Illumination: Only light seeping from windows, and two lamps spaced far apart give light here. It's dusk, that twilight zone where everything isn't light and is yet to be totally dark. This counts for shadowy illumination.

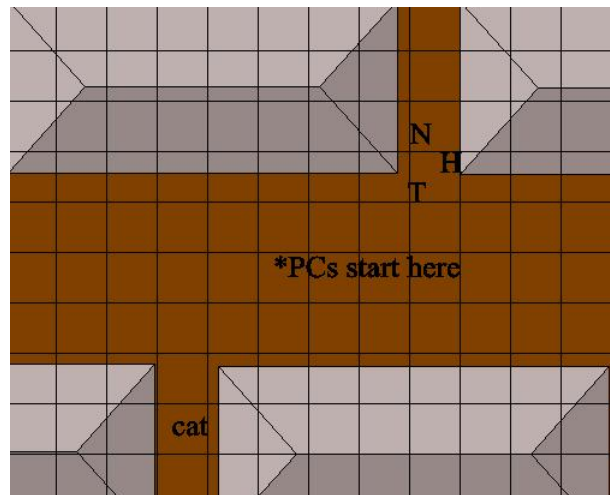

Treasure: Refer to Treasure Summary to determine what the PCs find here.

DEVELOPMENT

When the Battle is over PCs might want to do any of the following:

Secure and Question Prisoners: The prisoners know the following:

Hurig and Tiama

Attitude: Hostile (PH 72) unless the PCs promise not to turn them over to the Watch, in which case they become indifferent.

What Hurig Knows: Hurig knows only that they had to wear 'the stupid medusa-head thing' from the Pomarj – even though we'd never go trade there, at least, not until the war settles down.

The boss is pretty excited, though. This little caper paid enough to cover expenses for a three-month. Sellin' youse is just icing on the cake.

Sellin' happens in da north. There's a few places we might go, but da boss never tells us 'til we's almost there – a day out. And don't go askin' fer names. I ent one for remembering fancy names.

Nestra

Attitude: Hostile (PH 72) unless the PCs promise not to turn them over to the Watch, in which case she becomes indifferent.

What Nestra Knows: Nestra knows what Tiama and Hurig know, and that she's been charged with makin' sure that the cargo (that's you, you scum) get back to the sales yard in one piece.

Try and discover the slaver base: The slavers have made the mistake of attacking the PCs in an area not far from their base of operations. By asking around the area (knocking on doors, or coming back in the morning to question people in the neighborhood), the PCs can learn the following with a Gathering Information check:

DC 10: "We've seen 'em around here. They's new."

DC 15: "They's come early and late, but not during the day. No, during the day, they's hide out in Hollow Court... or under it."

DC 20: "How much?" the child's face is a comical mixture of eager to help and shrewd calculation. "How much to tell ye?" [PCs should name a price here; anything over 2 gp garners the following response: "Fer that I'll take ye, but youse ent allowed ter tell. Me ma 'ill kill me, if'n she finds out."] If PCs follow the lad and/or his directions, go to Encounter Four.

Modifiers for this check include:

- +1 for each gp spent (up to a maximum of 5 gp)
- +1 if they befriended Sameus and/or Moly.

If the PCs fail this check, have Sameus or Moly approach them with the information in apology for the ogre incident.

Search the bodies of the defeated slavers: Making a Search DCs reveals the following:

DC 20: Tucked away in one of the attacker's pocket is a note that leads them back to the slavers' headquarters. (Hurig was never any good at remembering place names or their significance, so his note is a simple line drawing of the streets they must follow. A DC 13 Decipher Script check reveals its relevance in relation to their current location.) If PCs decide to follow this clue, go to Encounter Four.

4: SLAVER HEADQUARTERS

PCs investigating the slavers' base discover more slavers – who need to be defeated before clues can be uncovered.

When the PCs arrive here, read:

After stepping under a ratchety staircase, and kicking aside a pile of debris, you find a hidden door.

Wooden stairs make your footfalls echo down a deep well, but nothing awaits you when you get to the small, round room at the bottom.

Thick, wooden doors block further progress.

When the PCs open the door, continue:

They doors open on silent hinges and lead into a stone-lined corridor. At the end of the corridor is another door.

PCs can approach how they like down this corridor. Their progress down the stairwell has probably alerted the inhabitants behind the door, unless they indicated that they approached using stealth. Since the inhabitants are expecting Hurig, Tiama and Nestra, however, the sound does not put them on alert. They are surprised to see the PCs, unescorted and hostile, coming through the door. Read:

The door opens onto a warmly-lit room. Inside a half-orc and a half-elf leap to their feet and reach for their weapons.

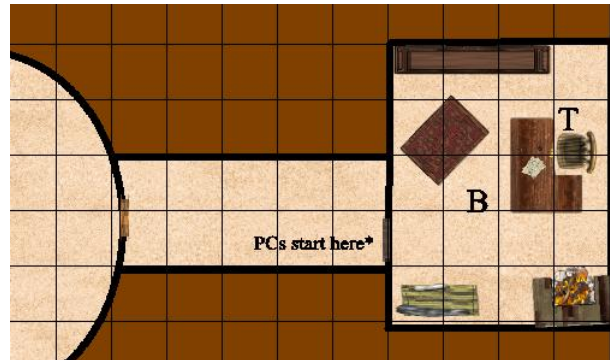

APL 2 (EL 3)

☛ **Thannis:** half-elf (Suel) fighter 1/bard 1; hp 11; Appendix 1.

APL 4 (EL 4)

☛ **Thannis:** half-elf (Suel) fighter 1/bard 1; hp 11; Appendix 1.
☛ **Bereth:** female half-orc fighter 2; hp 19; Appendix 1.

APL 6 (EL 6)

☛ **Thannis:** half-elf (Suel) fighter 1/bard 2; 14 hp; Appendix 1
☛ **Bereth:** Female half-orc fighter 3; hp 26; Appendix 1.

APL 8 (EL 9)

☛ **Thannis:** half-elf (Suel) fighter 1/bard 3; 17 hp; Appendix 1.
☛ **Bereth:** female half-orc fighter 4; hp 32; Appendix 1.

Thannis' Tactics: Thannis sings for the first round, and then casts *lullaby* (if he's still not engaged in melee). Using the desk to provide cover, he casts *sleep* and *charm person*, followed by any other offensive spells in his repertoire. He does not shirk combat. Being a trained fighter he begins a fighting retreat to maneuver to the

door and the stairwell if he thinks he and Bereth are going to lose.

Bereth's Tactics: Bereth's main aim is to provide protection for Thannis. She is his bodyguard, and adores him because he treats her like a real person and not a high-ranking slave. Bereth tries to keep the PCs occupied long enough for Thannis to use his spells, and protects his retreat if that becomes necessary.

AREA FEATURES

None that affect combat, beyond the obvious obstacles of the desk and chair, which can be used as cover.

Treasure: Refer to Treasure Summary to determine what the PCs find here.

DEVELOPMENT

Once they have defeated the slavers, PCs may wish to do the following:

Secure and Question Prisoners: The slavers know the following:

Bereth

Attitude: Hostile (PH 72) unless the PCs promise not to turn them over to the Watch, in which case she becomes indifferent. If PCs threaten to harm or kill Thannis in any way, Bereth can be forced up one notch of cooperation, but such a threat counts as Intimidation. If the PC follows through on the threat, it also becomes an evil act.

What Bereth Knows: Bereth knows that she has failed in her charge to protect Thannis. She doesn't care for the details of their business, beyond knowing how many complications (slaves) are likely to make her job harder.

Thannis

Attitude: Indifferent (PH 72) unless the PCs promise not to turn him over to the Watch, in which case he becomes friendly. Thannis is the classic mercenary; paid to do a job – nothing personal. If things have gone south, the only person he's in trouble with is his hirer – and he doesn't know enough to identify that particular person, so that's not a problem.

What Thannis Knows: Thannis knows that he works for slavers based in the north – or, he did, until he fouled up this mission; now it's time for a career change, and to find some different scenery. He'd like to take Bereth with him, if that's okay; she won't be welcome back north either.

They were to take the PCs north to meet up with the main body of the slavers – no specified location, just follow the prescribed route, and they'd be met.

Now? Now he's going as far east and south as he can manage, in the hopes that long arms can't reach him and sharp eyes can't see him. He needs to get lost and fast. He doesn't suppose the PCs would smuggle him and Bereth out of the city, would they? He could pay them...

Discover the Slaver's Boss: The slavers signed a contract that hires them to capture the PCs and remove them from 'the Greyhawk equation'. What they do with the PCs is up to them; it's just the PCs good luck that Thannis was under orders to capitalize on the expedition by taking them alive and then returning them north for sale. The contract is on the desk (DC 10 Search check). It's wording on the hirer's identity is obscure, naming the hirer as The Representative and nothing more.

Conclusion: Once the PCs are satisfied they have done all they can, they must decide what to do with the evidence. If all is reported, proceed to the appropriate Conclusion.

CONCLUSION: RESULTS AND REWARDS

SUCCESS: ALL, OR MOST, CLUES FOUND

For this conclusion, the PCs have found, or experienced, at least 4 of the following clues:

- Defeated the shadow creature ambush and discovered Greta's deception;
- The note in Palfrey's ledger;
- The list left behind at the inn;
- Linked the common factor of the elf wizard in most of the events;
- Seen the ogre tabards;
- Found out that the slavers trade out of the north;
- Found out that the slavers are puzzled by the need to wear the Pomarji symbol.
- Found the slaver contract.

Read, or paraphrase, the following to reflect the clues found by the PCs (if they did not find them all):

It takes a bit, but the authorities take in everything you tell them and, although they're disappointed that you didn't find any clues leading to Korenth's murderer, or how his death is linked to Etressa's, they are excited by what else has been revealed.

The Mak is not responsible. He's not responsible for the deaths of Korenth or Etressa, because he's not responsible for setting up the meeting in the Foreign Quarter, the ogres in High Street, or the slavers in the city.

All of this is indicated by the slavers puzzlement over the need to where the Pomarji coat of arms, and the fact that they traded in the north, the fact that the note sent to Palfrey wasn't written in Mak's hand (and, yes, they do have other letters for comparison).

While they'd dearly love to speak with this wizard, they're sure he's well beyond they're, reach, but they thank you for your efforts, and for showing them that rumors of the Mak's duplicity are exactly that – rumors.

PARTIAL SUCCESS: SOME CLUES FOUND

For this conclusion, the PCs have found, or experienced, less than four of the following clues:

- Defeated the shadow creature ambush and discovered Greta's deception;
- The note in Palfrey's ledger;
- The list left behind at the inn;
- Linked the common factor of the elf wizard in most of the events;
- Seen the ogre tabards;
- Found out that the slavers trade out of the north;
- Found out that the slavers are puzzled by the need to wear the Pomarji symbol.
- Found the slaver contract.

Read, or paraphrase, the following to reflect the clues found by the PCs (if they did not find them all):

While inconclusive, your findings have helped throw some doubt on rumors regarding the Mak's hand in the recent troubles.

As to a link between Korenth's and Etressa's deaths – they'll keep looking. Maybe they'll find what you seem to have missed.

DEFEATED BY SLAVERS

The PCs were defeated by the slavers and taken north.

You woke up feeling like you'd been trampled by a horse – a really angry horse with really big feet... and his friends, with their really big feet. This is bad.

Yep, that was bad, but not as bad as the months it took you to escape from the slavers' pens.

PCs earn the Slave AR Award.

AFFILIATION REWARDS

Now is the time to determine how many affiliation points each PC gained for their given affiliations. Record each PC's gain (or loss) on the Affiliations Score Gained/Lost AR item. PCs can gain the following points:

The Guild of Wizardry

- 1 point for rescuing Palfrey

Merchants and Traders Union

- 1 point for uncovering evidence that indicates that someone was trying to frame the Mak for the murders, when he wasn't involved.

Mercenaries' Guild

- 1 point for defeating the ogres.

Cartographers' Guild

- 1 point for mapping out the entry and tunnel to, and the slaver's headquarters.

Thieves' Guild

- 1 point for revealing the presence of the slavers in Greyhawk City, and for playing a part in defeating them.

Nightwatchmen

- 1 point for uncovering evidence that indicates that someone was trying to frame the Mak for the murders, when he wasn't involved.
- 1 point for revealing the presence of the slavers in Greyhawk City, and for playing a part in defeating them.

Religious Organizations

- 1 point for uncovering evidence that indicates Iuz, or his agents, might be involved in goings on in the City.

CAMPAIGN CONSEQUENCES

Report the following consequences to Creighton Broadhurst at creighton@greyworks.co.uk

1. Did the PCs discover Greta's deception and rescue her from the shadow creatures?
2. Did they turn her over to the Watch?
3. Did the PCs discover the list left behind by the wizard?
4. Did the PCs discover the note in Palfrey's ledger?
5. Did the PCs save the Wizard Palfrey?
6. Did the PCs defeat the slavers or were they captured by them?
7. Which conclusion did the PCs achieve?

EXPERIENCE POINT SUMMARY

To award experience for this adventure, add up the values for the objectives accomplished. Then assign the experience award. Award the total value (objectives plus roleplaying) to each character.

1A/2A: Answering the Invitation to the Foreign Quarter/Ambush in the Foreign Quarter

Defeat shadow krenshar

APL 2	90 XP
APL 4	150 XP
APL 6	210 XP
APL 8	270 XP

2B: Out of the Bag

Defeat the ogres

APL 2	120 XP
APL 4	180 XP
APL 6	240 XP
APL 8	300 XP

1C: Off to See the Wizard

Kill or capture the imp OR keep Wizard Palfrey alive

APL 2	60 XP
APL 4	60 XP
APL 6	60 XP
APL 8	60 XP

3B: Slaver Attack

Defeat the slavers

APL 2	90 XP
APL 4	120 XP
APL 6	180 XP
APL 8	270 XP

4: Slaver Headquarters

Defeat the slaver leaders

Objective(s) met:

APL 2	90 XP
APL 4	120 XP
APL 6	180 XP
APL 8	270 XP

Discretionary roleplaying award

APL 2	30 XP
APL 4	30 XP
APL 6	30 XP
APL 8	30 XP

Total Experience Available

APL 2	480 XP
APL 4	720 XP
APL 6	900 XP
APL 8	1,200 XP

Total Experience to be Awarded

APL 2	450 XP
-------	--------

APL 4
APL 6
APL 8

675 XP
900 XP
1,125 XP

TREASURE SUMMARY

During an adventure, characters encounter treasure, usually finding it in the possession of their foes. Every encounter that features treasure has a "treasure" section within the encounter description, giving information about the loot, coins, and magic items that make up the encounter's treasure.

The loot total is the number of gold pieces each character gains if the foes are plundered of all their earthly possessions. Looting the bodies takes at least 10 minutes per every 5 enemies, and if the characters cannot take the time to loot the bodies, they do not gain this gold. If you feel it is reasonable that characters can go back to loot the bodies, and those bodies are there (i.e., not carted off by dungeon scavengers, removed from the scene by the local watch, and so on), characters may return to retrieve loot. If the characters do not loot the body, the gold piece value for the loot is subtracted from the encounter totals given below.

The coin total is the number of gold pieces each character gains if they take the coin available. A normal adventuring party can usually gather this wealth in a round or so. If for some reason, they pass up this treasure, the coin total is subtracted from the encounter totals given below.

Next, the magic items are listed. Magic item treasure is the hardest to adjudicate, because they are varied and because characters may want to use them during the adventure. Many times characters must cast *identify*, *analyze dweomer* or similar spell to determine what the item does and how to activate it. Other times they may attempt to use the item blindly. If the magic item is consumable (a potion, scroll, magic bolts, etc.) and the item is used before the end of the adventure, its total is subtracted from the adventure totals below.

Once you have subtracted the value for unclaimed treasure from each encounter add it up and that is the number of gold pieces a characters total and coin value increase at the end of the adventure. Write the total in the GP Gained field of the adventure certificate.

Loot = Looted gear from enemy; Coin = Coin, Gems, Jewelry, and other valuables; Magic = Magic Items.

2B: Out of the Bag

APL 2: Magic 208 gp; bag of holding type I (208 gp); Total 208 gp.

APL 4: Magic 208 gp; bag of holding type I (208 gp); Total 208 gp.

APL 6: Magic 208 gp; bag of holding type I (208 gp); Total 208 gp.

APL 8: Magic 208 gp; bag of holding type I (208 gp); Total 208 gp.

3B: Slaver Ambush

APL 2: Loot 54 gp; Total 54gp.

APL 4: Loot 100 gp; Total 100 gp.

APL 6: Loot 100 gp; Total 100 gp.

APL 8: Loot 100 gp; Total 100 gp.

4: Slaver HQ

APL 2: Loot 34 gp; Magic 175 gp; *mithral shirt +1* (175 gp); Total 209 gp.

APL 4: Loot 62 gp; Magic 288 gp; *mithral shirt +1* (175 gp), *splint mail +1* (113 gp); Total 350 gp.

APL 6: Loot 68 gp; Magic 535 gp; *mithral shirt +1* (175 gp each), *mithral splint mail* (350 gp); Total 593 gp.

APL 8: Loot 7 gp; Magic 1,146 gp; 2 *+1 falchion* (198 gp each), *glamered mithral shirt +1* (400 gp), *mithral splint mail* (350 gp); Total 1,153 gp.

Treasure Cap

APL 2: 450 gp; **APL 4:** 650 gp; **APL 6:** 900 gp; **APL 8:** 1,300 gp.

Total Possible Treasure

APL 2: 471 gp; **APL 4:** 652 gp; **APL 6:** 901 gp; **APL 8:** 1,461 gp.

of speed, cloak of the arachnida, cloak of the bat, cloak of charisma +4, minor cloak of displacement, glove of storing. (Core access). Instead, you may learn one of the following spells for each TU you spend studying with him: *displacement*, *eagle's splendor*, *fly*, *haste*, *shrink item*, *spider climb*, *web*.

☛ **Slave!** You were captured by the slavers and spent 26 TU escaping their clutches with nothing but the shirt on your back. You gain no gold from this adventure, but do retain all other awards and may use the Charity of Friends clause in the LGAH to re-equip.

ITEM ACCESS

APLs 2-4:

Bag of holding type I (Adventure; 2,500 gp; DMG)

Mithral chain shirt +1 (Adventure; 2,100 gp; DMG)

APL 6 (all of APLs 2-4 plus the following):

Mithral splint mail (Adventure; 4,200 gp; DMG)

APL 8 (all of APLs 2-6 plus the following):

Glamered mithral shirt +1 (Adventure; 4,800 gp; DMG)

ADVENTURE RECORD ITEMS

☛ **Affiliation Score Gained/Lost:** by this PC with the _____ Greyhawk affiliation was # __ points. If multiple allegiance, add extra in notes section.

☛ **Gratitude of a City Bard:** For rescuing Greta Meyani from the shadow krenshar and not turning her in, she arranges Core access to one of the following at (at normal price) *eternal wand of charm person* (MIC), *eternal wand of sleep* (MIC), *eternal wand of daylight* (MIC, SpC). Circle the item chosen, and cross off this section of the favor once it has been used.

In addition, once per adventure set in Greyhawk City, she is willing to use the skills described in 'Owed a Bard's Debt' to fulfill your request for information or to smooth the way for you in social circles.

For an extra 1 TU per spell learned, Greta is willing to teach you the following spells: *ghostharp*, *lively step*, *minor disguise*, *serene visage*, *songbird*, *undersong*. (Core access; SpC spells)

☛ **Owed a Bard's Debt:** For saving her life (and then having her jailed) Greta Meyani owes you a debt. Once, and once only (and only in Greyhawk City), she will make up to three of the following skill checks for you. Cross off this favor once used.

Greta Meyani: female bard 6; bardic knowledge +10, Diplomacy +10, Gather Information +6, Knowledge (history, local-Greyhawk, nobility and royalty) +7.

☛ **Palfrey's Gratitude:** For saving his life, Palfrey's gratitude knows few bounds. He is willing to craft you one of the following, for 20% less than its usual price: *boots*

I: VISITING THE FOREIGN QUARTER

GRETA MEYANI **CR 6**

Female elven bard 6

CG Medium humanoid (elf)

Init +1; **Senses** Listen +3, Lowlight vision, Spot +3

Languages Common, Elven

AC 12, touch 11, flat-footed 11

(+1 Dex, +1 natural [*amulet of natural armor* +1])

hp 21 (6 HD)

Immune *sleep* effects

Fort +3, **Ref** +7, **Will** +7 (+9 against enchantment)

Speed 30 ft. (6 squares)

Melee dagger +3 (1d4-1/19-20)

Ranged dagger +5 (1d4-1/19-20)

Base Atk +4; **Grp** +5

Special Actions bardic music (10/day; *countersong*, *fascinate*, *inspire courage* +1, *inspire competence*, *suggestion*)

Bard Spells Known (CL 6th):

2nd (3/day)—*blur*, *lively step*, *suggestion* (DC 15)

1st (4/day)—*charm person* DC 14), *serene visage* †, *sleep* (DC 14), *undersong* †

0 (3/day)—*dancing lights*, *ghostharp*, *lullaby* (DC 13), *minor disguise*, *songbird*, *summon instrument*

† Already cast

Abilities Str 8, Dex 12, Con 10, Int 14, Wis 13, Cha 18

SQ bardic knowledge +10, elf traits

Feats Extra Music, Skill Focus (Perform [act]), Skill Focus (Perform [sing])

Skills Balance +3, Bluff +9 (+12 when *serene visage* is in effect), Diplomacy +10, Disguise +7 (+9 to act in character), Gather Information +6, Hide +1, Jump +1, Knowledge (history) +7, Knowledge (local – Greyhawk) +7, Knowledge (nobility & royalty) +7, Listen +3, Intimidate +6, Move Silently +1, Perform (act) +16, Perform (oratory) +13, Perform (sing) +16, Search +4, Sense Motive +6, Spot +3, Tumble +10

Possessions *amulet of natural armor* +1, *cloak of charisma* +2, *vest of resistance* +1, *symbol of luz*, dagger

APPENDIX 1: APL 2

1A/2A: VISITING THE FOREIGN QUARTER/AMBUSH IN THE FOREIGN QUARTER

SHADOW KRENSHAR **CR 2**
NE Medium magical beast (extraplanar – Shadow)
Init +2; **Senses** darkvision 60 ft., Listen +3, lowlight vision, scent, Spot +1
Languages None

AC 15, touch 12, flat-footed 13
+2 Dex, +3 natural)

Miss Chance 50% (*shadow blend*)

hp 11 (2 HD); fast healing 2

Resist cold 6

Fort +3, **Ref** +5, **Will** +1

Speed 60 ft. (12 squares)

Melee bite +2 (1d6) and
claws +0 (1d4)

Base Atk +2; **Grp** +2

Special Actions *scare*, *shadow blend*

Abilities Str 11, Dex 14, Con 11, Int 6, Wis 12, Cha 13

Feats Multi-attack, Track^B

Skills Bluff +1 (+3 when using *scare*), Hide +4, Jump +17, Listen +3, Move Silently +8, Spot +1,

Scare (Ex or Su) As a standard action, a krenshar can pull the skin back from its head, revealing the musculature and bony structures of its skull. This alone is usually sufficient to scare away foes (treat as a Bluff check with a +3 bonus).

Combining this scare ability with a loud screech produces an unsettling effect that works like a scare spell from a 3rd-level caster (Will DC 13 partial). A creature that successfully saves cannot be affected again by the same krenshar's scare ability for 24 hours. The shriek does not affect other krenshars. This is a supernatural, sonic mind-affecting fear effect. The save is Charisma-based.

Shadow Blend (Su) In any conditions other than full daylight, a shadow creature can disappear into the shadows, giving it total concealment. Artificial illumination, even a light or continual flame spell, does not negate this ability, but a daylight spell will.

Skills Krenshars have a +4 racial bonus on Jump and Move Silently checks. Shadow creatures have a +6 racial bonus on Move Silently checks; this supersedes the krenshar racial bonus.

3B: SLAVER AMBUSH

HURIG **CR 1**

Male half-orc fighter 1

CE Medium humanoid (orc)

Init +0; **Senses** darkvision 60 ft., Listen +1, Spot +2

Languages Common, Orc

AC 15, touch 10, flat-footed 15
(+4 armor, +1 shield)

hp 12 (1 HD)

Fort +3, **Ref** +0, **Will** +1

Speed 20 ft. in scale mail (4 squares), base speed 30 ft.;

Melee mwk morningstar +5 (1d8+3) or

Ranged light crossbow +1 (1d8/19-20)

Base Atk +1; **Grp** +3

Special Actions Combat Expertise

Abilities Str 14, Dex 10, Con 14, Int 13, Wis 13, Cha 8
SQ orc traits

Feats Weapon Focus (morningstar)^B, Combat Expertise

Skills Climb -3, Handle Animal +3, Hide -5, Intimidate +3, Jump -9, Listen +1, Move Silently -5, Ride +1, Search +0, Spot +2, Swim -2,

Possessions buckler, light crossbow + 12 bolts, masterwork morningstar, scale mail

NESTRA **CR 1**

Female half-orc cleric (Gruumsh) 1

CE Medium humanoid (orc)

Init +0; **Senses** darkvision 60 ft., Listen +1, Spot +1

Languages Common, Giant, Orc

AC 14, touch 10, flat-footed 14
(+4 armor)

hp 10 (1 HD)

Fort +3, **Ref** +0, **Will** +4

Speed 20 ft. in scale mail (4 squares), base speed 30 ft.

Melee sap +0 (1d6) or

Ranged light crossbow +0 (1d8/19-20)

Base Atk +0; **Grp** +0

Special Actions rebuke undead, spontaneous casting (*inflict* spells)

Cleric Spells Prepared (CL 1st):

1st—*bane* (DC 16), *charm person*^D, *lesser vigor*

0—*cure minor wounds* (3)

D: Domain spell. Deity: Gruumsh. Domains: Domination, Tyranny

Abilities Str 10, Dex 10, Con 12, Int 12, Wis 15, Cha 13
SQ orc traits

Feats Skill Focus (Concentration), Spell Focus (enchantment)^B

Skills Concentration +8, Diplomacy +1, Heal +4, Hide -5, Knowledge (arcana) +6, Knowledge (religion) +3, Listen +1, Move Silently -5, Search +1, Spellcraft +2, Spot +1

Possessions buckler, light crossbow + 12 bolts, sap, scale mail

4: SLAVER HQ

THANNIS

CR 2

Male half-elf (Suel) fighter 1/bard 1

NE Medium humanoid (elf)

Init +1; **Senses** lowlight vision; Listen +2, Spot +2

Languages Common, Elven

AC 15, touch 11, flat-footed 14

(+1 Dex, +4 armor)

hp 11 (2 HD)

Immune *sleep* effects

Fort +2, **Ref** +3, **Will** +3 (+5 against enchantments)

Speed 30 ft. (6 squares)

Melee mwk falchion +2 (2d4-1/18-20)

Ranged light crossbow +2 (1d8/19-20)

Base Atk +1; **Grp** +0

Special Actions bardic music 1/day (countersong, fascinate, inspire courage +1)

Bard Spells Known (CL 1st; 10 % spell failure):

0 (2/day)—*daze* (DC 12), *flare* (DC 12), *lullaby* (DC 12), *minor disguise*

Abilities Str 8, Dex 12, Con 10, Int 14, Wis 13, Cha 15

SQ bardic knowledge +3, elf traits

Feats Persuasive, Weapon Focus (falchion)^B,

Skills Balance +0, Bluff +6, Concentration +0, Diplomacy +10, Disguise +4, Gather Information +4, Hide +0, Intimidate +2, Jump +2, Knowledge (history) +6, Knowledge (local – Core) +6, Knowledge (nobility & royalty) +6, Listen +2, Move Silently +0, Perform (oratory) +3, Perform (sing) +5, Search +3, Sense Motive +5, Spot +2, Tumble +4

Possessions light crossbow with 12 bolts, mithral shirt, masterwork falchion

1A/2A: VISITING THE FOREIGN QUARTER/AMBUSH IN THE FOREIGN QUARTER

ADVANCED SHADOW KRENSHAR CR 4

NE Large magical beast (extraplanar – shadow)
Init +2; **Senses** darkvision 60 ft. low-light vision, scent;
Listen +5, Spot +1

AC 16, touch 11, flat-footed 14
(-1 size, +2 Dex, +5 natural)

Miss Chance 50% (*shadow blend*)

hp 57 (8 HD); fast healing 2

Resist cold 13

Fort +5, **Ref** +7, **Will** +3

Speed 60 ft. (12 squares)

Melee bite +11 (1d8+4) and
claws +9 (1d8+4)

Base Atk +8; **Grp** +16

Special Actions scare, *shadow blend*

Abilities Str 19, Dex 14, Con 15, Int 6, Wis 12, Cha 13

Feats Ability Focus (scare), Improved Natural Weapon
(claws), Multi-attack, Track^B

Skills Bluff +1 (+3 when using scare), Hide +4, Jump
+21, Listen +5, Move Silently +8, Spot +1

Scare (Ex or Su) As a standard action, a krenshar can
pull the skin back from its head, revealing the
musculature and bony structures of its skull. This
alone is usually sufficient to scare away foes (treat as
a Bluff check with a +3 bonus).

Combining this scare ability with a loud screech
produces an unsettling effect that works like a scare
spell from a 3rd-level caster (Will DC 13 partial). A
creature that successfully saves cannot be affected
again by the same krenshar's scare ability for 24
hours. The shriek does not affect other krenshars.
This is a supernatural, sonic mind-affecting fear
effect. The save is Charisma-based.

Shadow Blend (Su) In any conditions other than full
daylight, a shadow creature can disappear into the
shadows, giving it total concealment. Artificial
illumination, even a light or continual flame spell,
does not negate this ability, but a daylight spell will.

Skills Krenshars have a +4 racial bonus on Jump and
Move Silently checks. Shadow creatures have a +6
racial bonus on Move Silently checks; this
supersedes the krenshar racial bonus.

3B: SLAVER AMBUSH

HURIG AND TIAMA

CR 2

Male and female half-orc fighter 2

CE Medium humanoid (orc)

Init +4; **Senses** darkvision 60 ft., Listen +1, Spot +2

Languages Common, Orc

AC 15, touch 10, flat-footed 15
(+4 armor, +1 shield)

hp 19 (2 HD)

Fort +5, **Ref** +0, **Will** +1

Speed 20 ft. in scale mail (4 squares), base speed 30 ft.

Melee mwk morningstar +6 (1d8+3)

Ranged light crossbow +2 (1d8/19-20)

Base Atk +2; **Grp** +4

Special Actions Combat Expertise

Abilities Str 14, Dex 10, Con 14, Int 13, Wis 13, Cha 8
SQ orc traits

Feats Combat Expertise, Improved Initiative^B, Weapon
Focus (morningstar)^B,

Skills Climb -2, Handle Animal +4, Hide -4, Intimidate
+3, Jump -7, Listen +1, Move Silently -5, Ride +4,
Search +0, Spot +2, Swim -1,

Possessions buckler, light crossbow with 12 bolts,
masterwork morningstar, scale mail

NESTRA

CR 2

Female half-orc cleric (Gruumsh) 2

Medium humanoid (orc)

Init +0; **Senses** darkvision 60 ft., Listen +1, Spot +1

Languages Common, Giant, Orc

AC 14, touch 10, flat-footed 14
(+4 armor)

hp 15 (2 HD)

Fort +4, **Ref** +0, **Will** +5

Speed 20 ft. in scale mail (4 squares), base speed 30 ft.

Melee sap +1 (1d6)

Ranged light crossbow +1 (1d8/19-20)

Base Atk +1; **Grp** +1

Special Actions rebuke undead, spontaneous casting
(*inflict* spells)

Cleric Spells Prepared (CL 2nd):

1st—*bane* (2; DC 16 Will), *charm person*^D, *lesser
vigor*

0—*cure minor wounds* (4)

D: Domain spell. Deity: Gruumsh. Domains: Domination
Tyranny

Abilities Str 10, Dex 10, Con 12, Int 12, Wis 15, Cha 13
SQ orc traits

Feats Skill Focus (Concentration), Spell Focus
(enchantment)^B

Skills Concentration +9, Diplomacy +1, Heal +4, Hide -
5, Knowledge (arcana) +6, Knowledge (religion) +4,
Listen +1, Move Silently -5, Search +1, Spellcraft
+4, Spot +1

Possessions buckler, light crossbow + 12 bolts, sap,
scale mail

4: SLAVER HQ

THANNIS

CR 2

Male half-elf (Suel) fighter 1/bard 1

NE Medium humanoid (elf)

Init +1; **Senses** low-light vision; Listen +2, Spot +2

Languages Common, Elven

AC 16, touch 11, flat-footed 15

(+1 Dex, +5 armor)

hp 11 (2 HD)

Immune *sleep* effects

Fort +2, **Ref** +3, **Will** +3 (+5 against enchantments)

Speed 30 ft. (6 squares),

Melee mwk falchion +2 (2d4-1/18-20)

Ranged light crossbow +2 (1d8/19-20)

Base Atk +1; **Grp** +0

Special Actions bardic music 1/day (countersong, fascinate, inspire courage +1)

Bard Spells Known (CL 1st; 10 % spell failure):

0 (2/day)—*daze* (DC 12), *flare* (DC 12), *lullaby* (DC 12), *minor disguise*

Abilities Str 8, Dex 12, Con 10, Int 14, Wis 13, Cha 15

SQ bardic knowledge +3, elf traits

Feats Persuasive, Weapon Focus (falchion)^B,

Skills Balance +0, Bluff +6, Concentration +0, Diplomacy +10, Disguise +4, Gather Information +4, Hide +0, Intimidate +2, Jump +2, Knowledge (history) +6, Knowledge (local – Core) +6, Knowledge (nobility & royalty) +6, Listen +2, Move Silently +0, Perform (oratory) +3, Perform (sing) +5, Search +3, Sense Motive +5, Spot +2, Tumble +4

Possessions light crossbow +12 bolts, +1 *mithral shirt*, masterwork falchion

BERETH

CR 2

Female half-orc fighter 2

CE Medium humanoid (half-orc)

Init +4; **Senses** Darkvision 60 ft., Listen +5, Spot +5

Aura faint evil

Languages Common, Elven, Orc

AC 17, touch 10, flat-footed 17

(+7 armor)

hp 19 (2 HD)

Fort +5, **Ref** +0, **Will** +1

Speed 20 ft. in +1 *splint mail* (4 squares), base speed 30 ft.;

Melee mwk falchion +4 (2d4/18-20)

Ranged light crossbow +2 (1d8/19-20)

Base Atk +2; **Grp** +2

Abilities Str 10, Dex 10, Con 14, Int 13, Wis 13, Cha 10

SQ orc traits

Feats Alertness, Improved Initiative^B, Weapon Focus (falchion)^B,

Skills Climb -7, Hide -6, Intimidate +5, Jump -12, Listen +5, Move Silently -6, Search +0, Spot +5, Swim -6

Possessions buckler, light crossbow + 12 bolts, masterwork falchion, scale mail

**1A/2A: VISITING THE FOREIGN
QUARTER/AMBUSH IN THE FOREIGN
QUARTER**

**ADVANCED HALF-FIENDISH SHADOW
KRENSHAR CR 6**

NE Large outsider (extraplanar – Shadow)
Init +4; **Senses** darkvision 60 ft., low-light vision, scent;
Listen +12, Spot +6

Languages None

AC 21, touch 13, flat-footed 15
(-1 size, +4 Dex, +6 natural)

Miss Chance 50% (*shadow blend*)

hp 65 (8 HD); fast healing 2; **DR** 5/magic

Resist acid 10, cold 13, electricity 10, fire 10; **SR** 18

Immune poison

Fort +5, **Ref** +9, **Will** +3

Speed 60 ft. (12 squares); fly 30 ft. (average)

Melee bite +13 (1d8+4) and
claws +11 (1d8+4)

Base Atk +8; **Grp** +18

Special Attacks *smite good* 1/day (+8 damage)

Special Actions *scare, shadow blend*

Spell-Like Abilities (CL 8th):

3/day—*darkness, poison* (DC 19)

1/day—*desecrate, unholy blight* (DC 16)

Abilities Str 23, Dex 18, Con 17, Int 10, Wis 12, Cha 15

Feats Ability Focus (*scare*), Improved Natural Weapon
(claws), Multi-attack, Track^B

Skills Balance +8, Bluff +7 (+9 when using *scare*),
Hide +11, Intimidate +15, Jump +33, Listen +12,
Move Silently +21, Spot +6, Survival +6, Swim +11,

Scare (Ex or Su) As a standard action, a krenshar can pull the skin back from its head, revealing the musculature and bony structures of its skull. This alone is usually sufficient to scare away foes (treat as a Bluff check with a +3 bonus).

Combining this scare ability with a loud screech produces an unsettling effect that works like a scare spell from a 3rd-level caster (Will DC 13 partial). A creature that successfully saves cannot be affected again by the same krenshar's scare ability for 24 hours. The shriek does not affect other krenshars.

This is a supernatural, sonic mind-affecting fear effect. The save is Charisma-based.

Shadow Blend (Su) In any conditions other than full daylight, a shadow creature can disappear into the shadows, giving it total concealment. Artificial illumination, even a light or continual flame spell, does not negate this ability, but a daylight spell will.

Skills Krenshars have a +4 racial bonus on Jump and Move Silently checks. Shadow creatures have a +6 racial bonus on Move Silently checks; this supersedes the krenshar racial bonus.

3B: SLAVER AMBUSH

HURIG AND TIAMA CR 3

Male and female half-orc fighter 3

CE Medium humanoid (orc)

Init +4; **Senses** darkvision 60 ft.; Listen +1, Spot +3

Languages Common, Orc

AC 15, touch 10, flat-footed 15
(+4 armor, +1 shield)

hp 26 (3 HD)

Fort +5, **Ref** +1, **Will** +2

Speed 20 ft. in scale mail (4 squares), base speed 30 ft.;

Melee mwk morningstar +7 (1d8+3)

Ranged light crossbow +3 (1d8/19-20)

Base Atk +3; **Grp** +5

Special Actions Combat Expertise, improved Disarm

Abilities Str 14, Dex 10, Con 14, Int 13, Wis 13, Cha 8
SQ orc traits

Feats Combat Expertise, Improved Disarm, Improved Initiative^B, Weapon Focus (morningstar)^B,

Skills Climb -3, Handle Animal +4, Hide -5, Intimidate +4, Jump -9, Listen +1, Move Silently -5, Ride +5, Search +0, Spot +3, Swim -2,

Possessions light crossbow, masterwork morningstar, scale mail

NESTRA CR 3

Female half-orc cleric (Gruumsh) 3

CE Medium humanoid (half-orc)

Init +0; **Senses** darkvision 60 ft.; Listen +1, Spot +1

Languages Common, Ogre, Orc

AC 14, touch 10, flat-footed 14
(+4 armor)

hp 20 (3 HD)

Fort +4, **Ref** +1, **Will** +5

Speed 20 ft. in scale mail (4 squares), base speed 30 ft.;

Melee sap +2 (1d6)

Ranged light crossbow +2 (1d8/19-20)

Base Atk +2; **Grp** +2

Atk Options Point Blank Shot

Special Actions rebuke undead, spontaneous casting
(*inflict spells*)

Cleric Spells Prepared (CL 2nd):

2nd—*enthrall*^D (DC 15), *stabilize, veil of shadow*

1st—*bane* (2; DC 16), *charm person*^D, *lesser vigor*
0—*cure minor wounds* (4)

D: Domain spell. Deity: Gruumsh. Domains:
Domination, Tyranny

Abilities Str 10, Dex 10, Con 12, Int 12, Wis 15, Cha 13
SQ orc traits

Feats Point Blank Shot, Skill Focus (Concentration),
Spell Focus (enchantment)^B

Skills Concentration +10, Diplomacy +1, Heal +4, Hide -5, Knowledge (arcana) +6, Knowledge (religion) +6, Listen +1, Move Silently -5, Search +1, Spellcraft +4, Spot +1

Possessions buckler, light crossbow + 12 bolts, sap, scale mail

4: SLAVER HQ

THANNIS

CR 3

Male half-elf (Suel) fighter 1/bard 2
NE Medium humanoid (half-elf)
Init +1; **Senses** low-light vision; Listen +2, Spot +2
Languages Common, Elven

AC 16, touch 11, flat-footed 15
(+1 Dex, +5 armor)

hp 14 (3 HD)

Immune *sleep* effects

Fort +2, **Ref** +4, **Will** +4 (+6 agasint enchantments)

Speed 30 ft. (6 squares)

Melee mwk falchion +3 (2d4-1/18-20)

Ranged light crossbow +3 (1d8/19-20)

Base Atk +2; **Grp** +1

Special Actions bardic music 2/day (countersong, fascinate, inspire courage +1)

Bard Spells Known (CL 2nd:

1 (1/day)—*charm person* (DC 14), *sleep* (DC 14)

0 (3/day)—*daze* (DC 13), *flare* (DC 12), *lullaby* (DC 13), *minor disguise*, *songbird*

Abilities Str 8, Dex 12, Con 10, Int 14, Wis 13, Cha 15

SQ bardic knowledge +6, elf traits

Feats Persuasive, Spell Focus (Enchantment), Weapon Focus (falchion)^B,

Skills Balance +2, Bluff +7, Concentration +0, Diplomacy +16, Disguise +4 (+6 to act in character), Gather Information +6, Hide +1, Intimidate +4, Jump +6, Knowledge (history) +7, Knowledge (local – Core) +7, Knowledge (nobility & royalty) +7, Listen +2, Move Silently +1, Perform (oratory) +4, Perform (sing) +5, Search +3, Sense Motive +6, Spot +2, Tumble +8

Possessions light crossbow +12 bolts, *mithral shirt* +1, masterwork falchion

BERETH

CR 3

Female half-orc fighter 3
CE Medium humanoid (half-orc)
Init +4; **Senses** darkvision 60 ft.; Listen +6, Spot +6
Languages Common, Elven, Orc

AC 16, touch 10, flat-footed 16
(+6 armor)

hp 26 (3 HD)

Fort +5, **Ref** +1, **Will** +4

Speed 20 ft. in splint mail (4 squares), base speed 30 ft.

Melee mwk falchion +5 (2d4/18-20)

Ranged light crossbow +3 (1d8/19-20)

Base Atk +3; **Grp** +3

Abilities Str 10, Dex 10, Con 14, Int 13, Wis 13, Cha 10

SQ orc traits

Feats Alertness, Improved Initiative^B, Iron Will, Weapon Focus (falchion)^B

Skills Climb -4, Hide -4, Intimidate +6, Jump -9, Listen +6, Move Silently -4, Ride +0, Search +0, Spot +6, Swim -4

Combat Gear buckler, light crossbow + 12 bolts, masterwork falchion, mithral splint mail

1A/2A: VISITING THE FOREIGN QUARTER/AMBUSH IN THE FOREIGN QUARTER

ADVANCED HALF-FIENDISH SHADOW KRENSHAR CR 6

NE Large outsider (extraplanar – Shadow)
Init +4; **Senses** darkvision 60 ft., low-light vision, scent;
Listen +12, Spot +6

Languages None

AC 21, touch 13, flat-footed 15
(-1 size, +4 Dex, +6 natural)

Miss Chance 50% (*shadow blend*)

hp 65 (8 HD); fast healing 2; **DR** 5/magic

Resist acid 10, cold 13, electricity 10, fire 10; **SR** 18

Immune poison

Fort +5, **Ref** +9, **Will** +3

Speed 60 ft. (12 squares); fly 30 ft. (average)

Melee bite +13 (1d8+4) and
claws +11 (1d8+4)

Base Atk +8; **Grp** +18

Special Attacks *smite good* 1/day (+8 damage)

Special Actions *scare*, *shadow blend*

Spell-Like Abilities (CL 8th):

3/day—*darkness*, *poison* (DC 19)

1/day—*desecrate*, *unholy blight* (DC 16)

Abilities Str 23, Dex 18, Con 17, Int 10, Wis 12, Cha 15

Feats Ability Focus (*scare*), Improved Natural Weapon
(claws), Multi-attack, Track^B

Skills Balance +8, Bluff +7 (+9 when using *scare*),
Hide +11, Intimidate +15, Jump +33, Listen +12,
Move Silently +21, Spot +6, Survival +6, Swim +11,

Scare (Ex or Su) As a standard action, a krenshar can pull the skin back from its head, revealing the musculature and bony structures of its skull. This alone is usually sufficient to scare away foes (treat as a Bluff check with a +3 bonus).

Combining this scare ability with a loud screech produces an unsettling effect that works like a scare spell from a 3rd-level caster (Will DC 13 partial). A creature that successfully saves cannot be affected again by the same krenshar's scare ability for 24 hours. The shriek does not affect other krenshars. This is a supernatural, sonic mind-affecting fear effect. The save is Charisma-based.

Shadow Blend (Su) In any conditions other than full daylight, a shadow creature can disappear into the shadows, giving it total concealment. Artificial illumination, even a light or continual flame spell, does not negate this ability, but a daylight spell will.

Skills Krenshars have a +4 racial bonus on Jump and Move Silently checks. Shadow creatures have a +6 racial bonus on Move Silently checks; this supersedes the krenshar racial bonus.

3B: SLAVER AMBUSH

HURIG AND TIAMA CR 3

Male and female half-orc fighter 3

CE Medium humanoid (orc)

Init +4; **Senses** darkvision 60 ft.; Listen +1, Spot +3

Languages Common, Orc

AC 15, touch 10, flat-footed 15
(+4 armor, +1 shield)

hp 26 (3 HD)

Fort +5, **Ref** +1, **Will** +2

Speed 20 ft. in scale mail (4 squares), base speed 30 ft.;

Melee mwk morningstar +7 (1d8+3)

Ranged light crossbow +3 (1d8/19-20)

Base Atk +3; **Grp** +5

Special Actions Combat Expertise, improved Disarm

Abilities Str 14, Dex 10, Con 14, Int 13, Wis 13, Cha 8
SQ orc traits

Feats Combat Expertise, Improved Disarm, Improved Initiative^B, Weapon Focus (morningstar)^B,

Skills Climb -3, Handle Animal +4, Hide -5, Intimidate +4, Jump -9, Listen +1, Move Silently -5, Ride +5, Search +0, Spot +3, Swim -2,

Possessions light crossbow, masterwork morningstar, scale mail

NESTRA CR 3

Female half-orc cleric (Gruumsh) 3

CE Medium humanoid (half-orc)

Init +0; **Senses** darkvision 60 ft.; Listen +1, Spot +1

Languages Common, Giant, Orc

AC 14, touch 10, flat-footed 14
(+4 armor)

hp 20 (3 HD)

Fort +4, **Ref** +1, **Will** +5

Speed 20 ft. in scale mail (4 squares), base speed 30 ft.;

Melee sap +2 (1d6)

Ranged light crossbow +2 (1d8/19-20)

Base Atk +2; **Grp** +2

Atk Options Point Blank Shot

Special Actions rebuke undead, spontaneous casting
(*inflict* spells)

Cleric Spells Prepared (CL 2nd):

2nd—*enthrall*^D (DC 15), *stabilize*, *veil of shadow*

1st—*bane* (2; DC 16), *charm person*^D, *lesser vigor*

0—*cure minor wounds* (4)

D: Domain spell. Deity: Gruumsh. Domains:

Domination, Tyranny

Abilities Str 10, Dex 10, Con 12, Int 12, Wis 15, Cha 13
SQ orc traits

Feats Point Blank Shot, Skill Focus (Concentration),
Spell Focus (enchantment)^B

Skills Concentration +10, Diplomacy +1, Heal +4, Hide -5, Knowledge (arcana) +6, Knowledge (religion) +6, Listen +1, Move Silently -5, Search +1, Spellcraft +4, Spot +1

Possessions buckler, light crossbow + 12 bolts, sap, scale mail

4: SLAVER HQ

THANNIS

CR 4

Male half-elf (Suel) fighter 1/bard 3

NE Medium humanoid (elf)

Init +1; **Senses** low-light vision; Listen +2, Spot +2

Languages Common, Elven

AC 16, touch 11, flat-footed 15

(+1 Dex, +5 armor)

hp 17 (4 HD)

Immune *sleep* effects

Fort +3, **Ref** +4, **Will** +4 (+6 against enchantments)

Speed 30 ft. (6 squares)

Melee +1 *falchion* +4 (2d4/18-20)

Ranged light crossbow +4 (1d8/19-20)

Base Atk +3; **Grp** +2

Special Actions Bardic music (countersong, fascinate, inspire competence, inspire courage +1)

Bard Spells Known (CL 3rd; 10% spell failure)

1 (2/day)—*charm person* (DC 15), *herald's call* (DC15), *sleep* (DC 15)

0 (3/day)—*daze* (DC 14), *flare* (DC 13), *lullaby* (DC 14), *minor disguise*, *songbird*

Abilities Str 8, Dex 12, Con 10, Int 14, Wis 13, Cha 16

SQ bardic knowledge +7, elf traits

Feats Persuasive, Spell Focus (Enchantment), Weapon Focus (falchion)^B,

Skills Balance +2, Bluff +9, Concentration +0, Diplomacy +17, Disguise +5 (+7 to act in character), Gather Information +7, Hide +0, Intimidate +5, Jump +5, Knowledge (history) +7, Knowledge (local – Core) +7, Knowledge (nobility & royalty) +7, Listen +2, Move Silently +1, Perform (oratory) +9, Perform (sing) +9, Search +3, Sense Motive +6, Spot +4, Tumble +7

Possessions light crossbow +12 bolts, *glamered mithral shirt* +1, +1 *falchion*

BERETH CR 4

Female half-orc fighter 4

CE Medium humanoid (half-orc)

Init +4; **Senses** darkvision 60 ft., Listen +7, Spot +7

Languages Common, Elven, Orc

AC 16, touch 10, flat-footed 16

(+6 armor)

hp 32 (4 HD)

Fort +6, **Ref** +1, **Will** +5

Speed 20 ft. in splint mail (4 squares), base speed 30 ft.

Melee +1 *falchion* +6 (2d4+3/18-20)

Ranged light crossbow +4 (1d8/19-20)

Base Atk +4; **Grp** +4

Abilities Str 10, Dex 10, Con 14, Int 13, Wis 14, Cha 10

SQ orc traits

Feats Alertness, Improved Initiative^B, Iron Will, Weapon Focus (falchion)^B, Weapon Specialization (falchion)^B

Skills Climb -4, Hide -4, Intimidate +7, Jump -9, Listen +7, Move Silently -4, Ride +0, Search +0, Spot +7, Swim -4

Possessions buckler, light crossbow + 12 bolts, +1 *falchion*, *mithral splint mail* +1

PLAYER HANDOUTS

PLAYER HANDOUT 1 (INTRODUCTION: AN INVITATION TO THE FOREIGN QUARTER)

Dear Adventurer

You have information I seek, regarding matters that are close to my heart. If you would find light to destroy the darkness of ignorance, meet with me at the Golden Horseshoe Resting House between the seventh and eighth bells of the Grand Cathedral tonight.

A Concerned Friend.

#

PLAYER HANDOUT 2 (ENCOUNTER 3A: TO FIND AN ELVEN WIZARD)

Chores:

- 1. bag of holding - Wizard Palfrey*
- 2. ogres - Pomarj;*
- 3. messengers - use urchins???*

(don't forget tabards with medusa head)

- 4. contingency - actress*
- 5. check inquirers - temple*
- 6. slavers to clean up*
- 7. Wizard Palfrey - Skexac*

AFFILIATION BRIEFING SHEETS

GUILD OF WIZARDRY

Gamboral is still grieving his daughter and, as a result, his work is suffering. Divinations have shown that a common link runs between the death of his daughter and the death of Matriarch Ipzeril's servant Korenth. They also show that the trail starts abroad but aren't more clear than that. See if you can clarify the connection.

MERCHANTS' AND TRADERS' UNION

The peace deal between Turrosh Mak and the City of Greyhawk is very important to us. We need the war to subside and trade routes to open once more. Divinations show that something isn't right, but can't be teased into clarification. They also show that the trail starts abroad, but aren't more clear than that. If you see any way to clarify the connection as you traverse the city, let us know.

MERCENARIES' GUILD

The war with Mak was good for some parts of our business and bad for a whole lot of other reasons, but that isn't what we want you to investigate. That wizard Gamboral has asked us to investigate the death of his daughter. The problem is that the only leads he can give us is from a divination that links his daughter's death with the death of Korenth, Matriarch Ipzeril's servant, and indicates that the trail starts abroad. See what you can find out for us. While you're at it, you should keep an eye out for mercenaries that come from elsewhere – there seem to be a few foreigners in Greyhawk, and we'd like to know who's paying them instead of hiring from us.

CARTOGRAPHERS' GUILD

With all the trouble with Mak and various problems arising in the ruins, we'd like you to keep an eye open for secret paths in the city. If you notice any that seem of particular interest, map them out and inform us.

THIEVES' GUILD

There's something secret going on – no, seriously, something is afoot and we mean more than usual. We suspect that foreign interests are moving in on our territory, but we can't pinpoint who, or where. And that wizard, Gamboral, has been yammering about his daughter again. Something about a divination linking her to Korenth and the trail starting abroad. Look into that as well. We need information on what's happening in the City, and we need it fast. See what you can do.

NIGHTWATCHMEN

There's trouble brewing – and we mean more than the usual sort. You're a watchman; start watching. The rumor's out that there's a link between Korenth and Gamboral's daughter. Not a romantic link, you single-minded ninny! A link between their murders, along with some hinting at foreign involvement. See what you can find out.

RELIGIOUS ORGANIZATIONS

The Matriarch of St. Cuthbert is still upset about the death of her servant. Her most recent divinations into the matter have shown that his murder is somehow linked to the death of that adventurer in the ruins of Greyhawk Castle. What adventurer? Oh, the girl, daughter of that wizard, Gamboral. We've more important things to chase, but we did a bit of dabbling that revealed the trail starts abroad. We'd like you to see if you can find out what it means. And keep an eye out for clues – apparently 'foreign interests' are threatening the peace treaty with the Mak, and we can't have that. Bad for business. Very bad indeed.

Little Things

By Colleen Simpson

Come see the treasures from the ruins of Greyhawk! Come see the magical mirrors, the ornate carvings, the beautiful statues. Come see the tapestry drag one of our patrons into itself... Now hold it right there – that wasn't something you expected. Are you just going to stand there? Or are you going to go to the rescue? A one-round Core adventure set in a location attached to the ruins of Greyhawk and Greyhawk City for characters level 1-10 (APLs 2-8).

ADVENTURE BACKGROUND

When Zagig created the God Trap, he had a number of gods in mind for his little device. Not all of them succumbed to his plans, however, and some of his preparations exist to this day. One such device is a 'little something' he cooked up for Bralm – Suel god of insects and industry.

Stealing an amulet that enhanced Bralm's control over all things that crawl, Zagig formed a demi-plane that was a joy for all insects – giant plants, huge flowers, a great climate, and so on. He then set about populating it with all the bugs he could find. Of course, he also added predators, no need to let the little terrors get out of hand – and who could resist making them big enough to see with the aid of an *enlarge* spell?

Setting this domain under the demi-plane known as the Isle of the Ape in a huge cavern, Zagig then placed the amulet in a maze of tunnels and traps designed to keep the deity's attention diverted from his real intentions, for, when the god touched his amulet, he would be transported into the god trap and thus fuel Zagig's own ascension.

Suspecting some kind of trap, and not really needing his amulet, Bralm avoided the trap, until he discovered that he and Zagig weren't the only ones who knew of it. Incabulos (as a side effect of the actions of his servants in the ruins – CGR7-01:4 *Soiled Souls*) has also discovered the amulet's whereabouts and plans to take it in order to enhance his own power, and decrease Bralm's. If all goes well, Incabulos means to steal the portfolio of insects from his rival, and use the amulet and disease-bearing vermin to spread his power across the Oerth.

Knowing a little of Zagig and his schemes, and suspecting something of the nature of the amulet's resting place, Incabulos has set his minions the task of discovering the location of the demi-plane, its entrance, and of retrieving the amulet.

Of course, knowing that deities might grow suspicious, Zagig set one final trap – a disease that infects the entire demi-plane and gradually turns its victims into

the mindless vermin that populate it. Hiding the entrance in a tapestry, he has let the years take their course.

With several entrances, the demi-plane attracted the attention of a variety of creatures, vermin and researchers into all things 'buggy'. Predators, in the form of giant spiders, also found the demi-plane a suitable home... as did a group of shaedlings who worshipped such monsters as representatives of Lolth. One such creature, a harpoon spider, has made its lair in the center of the maze, and the shaedlings are on a continual search for prey with which to feed it.

Recently, Greyhawk's Guild of Wizardry decided to take advantage of the interest the ruins were generating, and uncover some of the more unusual treasures extracted from their depths. One of these was the tapestry hiding an entrance to the demi-plane.

ADVENTURE SUMMARY

INTRODUCTION

PCs are visiting an exhibit of the 'Treasures of the Ruins' at the Guild of Wizardry, when one of the visitors ahead of them reaches out to touch a tapestry displaying a wild array of strange flowers, through which they glimpse a crystalline spire, and disappears. PCs may choose to touch the tapestry and be drawn in as their predecessor was (go to Encounter 1B), or to wait for directions, in which case, they are instructed to go through the tapestry. PCs may also learn of others who have vanished while near the tapestry.

ENCOUNTER 1

PCs enter the tapestry, succumbing to its magic. As they exit the tangled web-like threads that surround them on entry, they find themselves falling, and quickly saved by the wings that have appeared on their back. Even as they register that they can fly, (and the person they seek being dragged into the distance by a number of large shaedlings), they themselves are attacked by shaedlings.

PCs either fight them off (Encounter 2a), or succumb to their attack (Encounter 2b).

ENCOUNTER 2A

The PCs are in time to see the shadowy sprites hovering over a crystalline maze. The sprites drop the visitor, who *feather falls* into a hole at the top of the maze. The top of the maze closes over a terrified scream. The sprites wait for the PCs to confront them. When the PCs confront them, the sprites direct them to the entrance of the maze stating if they are quick, they can save the 'sacrifice'. If they are slow, they will join him. If the PCs attack the sprites, they continue to hear screams from the maze below. Each round they delay, they lose the chance to save one of the 'vanishing victims'. If they enter immediately, they have a very small chance of rescuing them all.

ENCOUNTER 2B

PCs find themselves inside the entrance of the maze.

ENCOUNTER 3 – THE MAZE

This is a loose series of encounters in which PCs must defeat the inhabitants of the maze and seek the way out, which, of course, lies in the maze's center. A note on the *teleportation* traps – these all deliver PCs to the center of the maze, from which they must escape if they wish to survive the harpoon spider and rejoin their comrades.

Encounter 3A: PCs come across a trapped rogue, who is on an elevated island in the middle of a swamp in which a strider swarm has made its home. They need to rescue the rogue, and work out a way to cross the swamp.

Encounter 3B: In a little room, the missing Mistress Marda is holding a fetid fungus at bay. PCs may rescue her.

Encounter 3C: This corridor contains a gelatinous cube that has so far frustrated all efforts of the shaedlings to destroy it. To continue down the corridor, the PCs must either avoid it, using the secret door, or defeat it in combat. (Where game play time is important, avoiding this combat is advised.)

Encounter 3D: PCs must either defeat, or successfully escape the swarm that lives in this room.

Encounter 3E: Huge vines lurk in the dense undergrowth in this chamber. They guard the entrance to a cell where another of the missing persons has hidden himself.

Encounter 3F: The PCs must work out the answer to three riddles and then drop the named item into a slot in order for the door to open. Alternatively, they can just hack their way through.

Encounter 3G: The PCs encounter a third prisoner, who is petrified of the fire beetles that have made their home in this cavern. They must either avoid the usually peaceful creatures, or defeat them.

Encounter 3H: Incabulos' minions have made it this far, and are preparing to make their way down to the harpoon spider lair. If the PCs have made a lot of noise

defeating the fire beetles, the minions have set an ambush, otherwise, the PCs may gain the upperhand.

Encounter 3I: The PCs must defeat the harpoon spider, to retrieve the amulet, and work out how to return to the City of Greyhawk. Go to Encounter 4.

ENCOUNTER 4

The pillar expels those, reaching into a recess marked by the symbol of an open door, from the maze. They end up standing in front of the tapestry.

CONCLUSION

Rewards according to those they rescued. For identifying the tapestry's tendency to pull people into a demi-plane (which is identified as being located beneath the Isle of Apes) PCs may also be rewarded.

PREPARATION FOR PLAY

AFFILIATION BRIEFING SHEETS

Many of the PCs participating in this adventure will be members of one of the free city's affiliations (as detailed in the *Greyhawk Ruins Sourcebook*). Before play begins, hand out the relevant briefing sheet to each player. PCs not belonging to any affiliation must determine for themselves why they are visiting the exhibition.

OPTIONAL ENCOUNTERS

GMs should note that there is a section of optional encounters to use when running this adventure outside a time-sensitive environment. If running this adventure in a time-sensitive environment, then the relevant rooms are empty of any opponents (although their appearance matches the description given in each section sans). PCs completing the optional encounters spend an extra TU and gain an additional AR for this zone.

RULE ITEMS

DMs should re-familiarize with the following rules before play:

- **Weapon hardness and hit points** (DMG 222). These are relevant to Encounter 3B.

ERRATA

Rules items affected by the official FAQ or erratas are as follows:

Listen Skill: Be aware that DC modifiers have changed for the last two numbers in this entry, from -1 to +1 and -5 to +5.

Ooze, Gelatinous Cube: Stats have been included here as they have been errataed since the *Monster Manual*.

Dread Blossom Swarm: has been errataed, but the errata has no effect on this module.

Harpoon Spider has been errataed – errata have been included in the stat blocks provided.

Swamp Strider Swarm has been errataed – errata has been included in the stat blocks provided.

Soft Cover: Soft over only works against ranged attacks.

INTRODUCTION

PCs are visiting an exhibit of the 'Treasures of the Ruins' at the Guild of Wizardry. Read:

*Well, the Academy sure knows how to turn it on. The crowd is really something, everybody oohing and aahing, and the items on display are nothing short of spectacular – or they were, until you reached this section. Not that you have anything against tapestries, mind you, but none of the plaques are able to tell you *exactly* what each one does. They were all found in the ruins, though, so surely they're not just for decoration...*

Give the PCs time to interact with each other, and state what they are doing, then read:

Just as you're beginning to think the tapestries are nothing more than pretty pictures – extremely fine and very expensive pretty pictures, but pictures none-the-less, there is a startled shout from ahead of you.

There, disappearing into one of the pretty pictures, is a mage. Or maybe he was dragged... Either way, he's getting a much closer view than he intended!

Let the PCs declare what they are doing. If they approach the tapestry for a closer look, read:

The man has disappeared completely, by the time you reach the tapestry.

Peering at the tapestry more closely, you notice that it's filled with exotic plants and flowers, and gaudily-colored flying insects with iridescent wings. In the distant, partly obscured by plants, is a gleaming, crystalline spire.

All around you, other patrons are scattering in shock, although some linger with the fascinated interest of someone watching a tragedy unfold.

From nearby, a studious-looking wizard nods as though something has been made clear. "Well, that explains a lot," he says.

Let PCs decide what to do.

DEVELOPMENTS

Interviewing the Wizard: If PCs approach the studious-looking wizard and speak with him, use the notes below to run the encounter.

Wizard Shamri

Attitude: Indifferent (PH 72) unless PCs suggest they are going to get the wizard back, then friendly.

What Shamri Knows: Shamri is aware that a number of people have disappeared in recent days. Most of them wizards, although he suspects there was an intruder that also disappeared because the alarms went off, but no intruder was found. Interestingly enough, that was in this hall as well – and, now, he thinks he knows why. He is most concerned because a friend of his, one Mistress Marda also disappeared – and it was she who lent this tapestry for the display. Shamri has suspected for a while, but this is the first time he has been able to witness anything happen. The PCs *will* go and rescue Marda for him, won't they?

♣ **Wizard Shamri:** male human (Suel) wizard 6

Gathering Information: PCs can discover the following through Gather Information checks:

- **DC 5:** This isn't the first disappearance that's occurred at the Guild of Wizardry.
- **DC 10:** A number of wizards have disappear lately.
- **DC 15:** An intruder disappeared as well – we think he was in this room.
- **DC 20:** Mistress Marda lent this tapestry for the display, but she wasn't around to hand it over for collection (although it was mostly packaged up and ready to go, when the guild representatives went to fetch it).

Going after the Tapestry Victim: PCs who touch the tapestry, or who deliberately try to follow the victim, immediately go to Encounter One.

Looking for Orders/Rewards: PCs who seek instructions from their faction are asked why they didn't follow immediately. They are told that there are always rewards for the noble of heart – and pity help those who hesitated to lend a hand for the sake of greed!!

1: THROUGH THE LOOKING GLASS

The PCs enter the tapestry willingly, succumbing to its magic. They appear in a huge cavern – so large that from their arrival point they may not even know they are in a cavern. Read:

You feel the tapestry's magic began to tug you in as sticky threads grasp your hand. You fall into a swirl of color and silence. The silence is short-lived, however, and you emerge into the open 'sky' falling.

... Or not falling, you discover, as the wings on your back snap open and you start to glide towards the leafy canopy below.

In the distance, you hear shouts, and notice that the tapestry's latest victim is being dragged through the air by large dark creatures that look remarkably like big malevolent faeries.

Even as you notice this, a second group of equally large faeries flies upwards from the trees to meet you.

Wisps of thick darkness trail from their bulging bellies, and their dragonfly wings glimmer with darkness.

Wings: The magic of the tapestry has temporarily given the PC wings (speed 30 ft., manouverability class: good).

BATTLE

The PCs can learn more about these creatures with a Knowledge (nature) check).

- **DC 12:** This creature is a shaedling, a hateful fey with a command over shadow. This result reveals all fey traits.
- **DC 17:** The spinnerets on a shaedling's bellow allow it to form weapons and other implements from shadowy strands. A shaedling can also weave a wall of shadow to block sight.
- **DC 22:** Shaedlings can use a special javelin to put a creature and potentially, all who touch that creature to sleep. Their tough skin is best cut by cold iron.

A successful DC 20 Knowledge (religion) check reveals that shaedlings have been known to follow the Spider Queen, Lolth.

APL 2 (EL 5)

☛**Shaedlings** (2): hp 22 each; Appendix 1.

APL 4 (EL 6)

☛**Shaedlings** (3): hp 22 each; Appendix 1.

APL 6 (EL 7)

☛**Shaedlings** (4): hp 22 each; Appendix 1.

APL 8 (EL 8)

☛**Shaedlings** (6): hp 22 each; Appendix 1.

Tactics: The shaedlings attack using sleeping curse in the opening round. They target heavily armored characters first, and then focus their efforts on those less well-protected. They work in concert, and use tactics such as flanking. When a PC succumbs to their attacks, the shaedlings note where they have fallen, and then focus on the remaining PCs.

Falling in Battle: PCs who fall in battle, fall 50 feet to the canopy and then another 20 feet to the floor. The canopy is a giving surface, and the myriad of plant life is mainly soft-stemmed (being giant plants and not trees). This, combined with the effect of their wings, reduces damage to 2d6 at APLs 2-4, and 3d6 at APLs 6-8.

AREA FEATURES

There is no map provided for this encounter as it takes place in the air above the canopy. Treat the battle ground as open space.

Cavern: The demiplane is set in a huge cavern. The ceiling is so distant that initially the PCs may not realize they are underground.

Light: Light fills the cavern radiating from the cavern ceiling high above (another of Zagig's enchantments). The light mimics the rise and set of the sun.

DEVELOPMENTS

PCs who defeat the shaedlings proceed to Encounter 2A.

PCs who are defeated by the shaedlings proceed to Encounter 2B.

2A: INTO THE MAZE WILLINGLY

The PCs have defeated the shaedlings that came to meet them and are in time to see the original group of shadowy sprites hovering over a crystalline maze. Read:

As your last foes dissipates into a thick streamer of greasy darkness, you see what has become of the visitor who fell through the tapestry. You are in time to see the dark-skinned sprites drop him through the roof of a pink crystalline structure.

In a flash, the gap they created closes over, cutting off their victim's terrified scream.

The sprites notice your advance, and turn to face you. They appear to be waiting for you to draw closer and hold their weapons in a neutral pose.

Give the PCs time to declare their actions.

SPEAKING WITH THE SPRITES

If the PCs choose to parlay instead of attack, read:

The sprites eye you warily, before drifting down to the surface of the large structure. It's pink surface reflects their images back, but does nothing more. You can see no trace of the opening through which their victim fell, although a terrified cry filters out from beneath your feet.

"Do you wish to enter?" asks the leader of the fey.

If the PCs agree, go to The Entrance. If they wish to speak more, the sprites know the following information.

Shaedling Leader

Attitude: Unfriendly (PH 72) unless PCs agree to enter the maze, then indifferent.

What the Leader Knows: The leader knows that the being they worship (a representative of Lolth) resides in the center of the maze. They feed it whatever prey they can find, although the hunting has been more favorable

of late. (He smiles at this.) Sometimes a window opens in the sky, through which they can draw all manner of creatures to delight their god. He is willing to open a way into the maze, but it is up to the PCs to rescue who they may. As best as he can recall, there have been four offerings made in the last few days. He is willing to reveal that there are insectivorous creatures within the maze.

☛ **Shaedling Leader:** male shaedling; Appendix 1.

ATTACKING THE SPRITES

If the PCs attack the sprites, they face a group equivalent to the one they have just defeated. Each round, the sprites offer the PCs the chance to enter the maze, asking them if they're sure they want to waste time in battle when there are those in mortal danger.

If the PCs break off the battle, the sprites show them a way in. Go to The Entrance.

If the PCs defeat the sprites, they must make a DC 23 Search check to find the entrance. Each attempt takes a day, because of the size of the maze. For every day they spend searching for the entrance, randomly determine which NPC falls to the maze's denizens. Flying out is not an option. The tapestry has been covered over and is not currently functioning as a portal.

If the PCs are defeated by the sprites, to Encounter 2B.

THE ENTRANCE

Once PCs have agreed to let the sprites show them the entrance to the maze, read:

The sprites lead you to a portion of the crystal covered over by a mass of vines, and shrouded beneath enormous yellow blossoms.

With a simple word, the crystal opens before you, and the sprites step back.

"May your gods bring you luck," their leader sneers, after you have entered. You watch as he launches himself into the air, and the crystal morphs close, leaving no trace of a door. As the last piece of outside world disappears from view, you notice the wings disappear from your companions' backs, and feel their weight leave your own.

Go to Encounter 3A.

2B: INTO THE MAZE, UNWILLINGLY

The PCs recover are just inside the entrance of the maze.

Finding yourself alive is somewhat of a surprise. Finding yourself in a corridor bordered and roofed by pink crystal is not. Well, there has to be a way out of here – and you might find the missing victims on the way. There's only one way to find out, though.

And speaking of missing – what's happened to your wings? They, too, seem to have gone missing,

although there's no evidence of injury to explain their disappearance.

Move to Encounter Three when the PCs begin to explore.

3: THE MAZE

This is a loose series of encounters in which the PCs must defeat the inhabitants of the maze and seek the way out, which, of course, lies in the maze's center. When the PCs first arrive in the maze, read:

The corridor you find yourself in is ten feet wide, and veers to the left around a bend. To your right, is another corridor – narrower, only five feet wide and turning left in a sharp right-angled bend after some fifteen feet. Light filters through the crystal, bathing all around you in a soft, pink glow.

Ahead of you, from around the left-veering bend, you hear a faint shriek. Male, or female, you cannot tell.

Let the PCs decide which way they want to travel and run encounters accordingly. If they follow the shriek, read:

Rounding the corner, you see the corridor ends in a larger chamber about 40 feet ahead. The shrieks, however, seem to be coming from a much narrower side corridor to your left.

If PCs follow the shrieks, go to Encounter 3B.

MAZE FEATURES

Ceilings: Unless otherwise noted, the ceilings in this section are 15 ft. high. They consist of 10-ft.-thick semi-opaque pink crystal.

Floors: Floors are paved stone.

Lighting: Lighting consists of natural light that filters through the crystalline structure of the walls and ceiling. It is tinged pink from the crystal it passes through.

Walls: Unless shown as a different thickness on the map, the walls consist of 10-ft.-thick, semi-opaque, pink crystal. Dark lines bordering areas show the edge of the wall, only. Thickness is dictated by distance between rooms to a maximum of 10 feet. After that, the wall ends, and the vegetation of the demi-plane begins.

Some PCs might wish to determine what kind of crystal surrounds them. Knowledge (geography) checks achieving the following DCs result in the following:

- **DC 10:** It's a hard, crystalline rock.
- **DC 15:** Looks like some type of rose quartz, but it isn't.
- **DC 20:** Similar to amethyst, you think, but this strange pale pink color. Nothing pink about its hardness, though.

Traps: Once designed to teleport hapless victims to the top of the spire, these traps have long been disabled by the shaedlings, who discovered it was better to let the

prey roam through the maze to the center of the trap – it appeals to their malicious sense of humor for a victim to believe the center of the maze was the way out, when it was the end of the line (and insects can always be dropped directly into the lair for the spider to eat, if prey is scarce. Besides, making sure that intelligent prey negotiates the maze ensures that only the most worthy sacrifices reach their deity's table.

Optional Encounters: These encounters are not to be run in a time sensitive environment. If PCs traverse these areas, and are NOT undertaking the optional encounters, then these areas are empty of enemies, but otherwise fit the descriptions provided.

3A – WATERY DEMISE

PCs come across a trapped rogue, who is on an elevated island in the middle of a swamp in which (at APLs 4 and above), a strider swarm has made its home. They need to rescue the rogue, and work out a way to cross the swamp. When they reach this area, read:

The corridor is blocked by a large, deep pit. The crystalline walls fall, in an unbroken cliff to the surface of what appears to be a sunken lake, and ferns and flowers grow from crevices all the way down. Something shimmers and moves across the water's surface, as though it chases the myriad shiny insects that make their home here.

What captures your attention the most, however, is the frightfully thin man huddled on top of a crystalline spire that rises out of the lake. Just when you think he's dead, he raises his head and fixes you with a desperate gaze. "Help me," he croaks, his voice barely audible above the sound of insectivorous wings.

If players ask for further clarification, draw them a map and read:

The pit is between thirty and thirty-five feet long and takes up the full twenty-foot width of the chamber. The water is thirty feet below you, and the top of the man's spire is twenty feet from where you stand and ten feet below you.

REACHING SAMAEL

Climb: PCs need to make a succession of DC 20 Climb checks to successfully move across the wall. Each check allows them to move one quarter their normal movement speed.

Jump: To jump across the pit, PCs need to make a DC 35 Jump check. To jump to the pillar on which Samael is stranded, the PC must make a DC 25 Jump check followed by a DC 15 Balance check to avoid falling off the other side or running into the NPC and knocking him off the ledge as they both fall.

Use Rope: It is possible to secure a grappling hook on the other side of the pit. This requires a DC 16 Use Rope

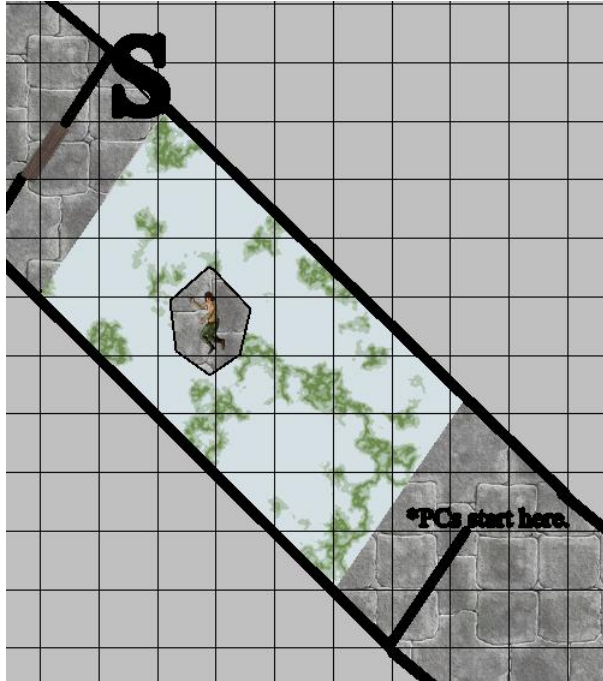

check. To secure a grappling hook on the pillar top, only requires a DC 14 Use Rope check.

The following creatures can be avoided, if PCs do not fall into the water. In this case, they earn experience for successfully crossing the pit without falling in, and for rescuing Samael.

APLs 4-6 (EL 5)

☛ **Swamp Strider Swarm (1):** hp 40; Appendix 1.

APL 8 (EL 7)

☛ **Swamp Strider Swarm (2):** hp 40 each; Appendix 1.

Tactics: The swamp striders do not attack anything that does not come in contact with the water. Once something does come into contact with the water, the swamp striders take one round to form an effective swarm and one round to approach.

LEARNING MORE

A DC 24 Knowledge (arcana) check (once the swarm has been identified) reveals that swamp strider feet have sometimes been used as components in the *water walk* spell.

Knowledge (nature) checks achieving the following DCs reveal the following:

- **DC 19:** That mat of bugs on top of the water is a swamp strider swarm that can't be damaged by weapons or targeted spells.
- **DC 24:** It's made up of very small beetles that are susceptible to area attacks and high winds.

- **DC 29:** They cause wounds that keep bleeding, and feed on the blood. Being swarmed can make you feel too sick to do anything but flee. These creatures can sense anything entering the same body of water they occupy, and walk on top of the water. They're very hard to drown.

A DC 22 Survival check (once the swarm has been identified), reveals that swamp striders are hunted by some humanoids and toasted as a delicacy. The beetles are 7 inches long and weigh half a pound providing a viable meal.

TALKING TO SAMAEL

Attitude: Helpful (PH 72)

What Samael Knows: He was 'only looking' at the tapestry (okay, he was touching it, but he wasn't really going to take it – well, not yet anyway). He had a partner in the gallery – Jarrett; did you find him? He doesn't know a way out of the maze and begs to tag along with PCs. He also asks that he not be handed over to the Watch. After all, hasn't he been punished enough?

☛ **Samael:** male human rogue 4.

DEVELOPMENT

After solving this problem, PCs may do one, or more, of the following:

Check for secret doors. The elven ability to find secret doors, and the dwarven stonemasonry ability are useful here. A successful DC 20 Search check reveals the secret door.

PCs continue their exploration of the maze. Go to whichever encounter is appropriate.

The PCs rest for the night. Take into consideration any disease effects. When they continue, go to whichever encounter is most appropriate.

3B: KICKING UP A STINK

In a little room, Mistress Marda is holding the fetid fungi at bay via her last *repulsion* spell, and the little monsters have her petrified. When the PCs arrive, read:

APLs 2-4

Guided by her shrieks of denial and desperation, you make your way down the narrow corridors until you reach a small, crystalline room.

A tall woman, with wavy dark hair and large, blue eyes has been cornered by what looks like two bubbling multi-colored boulders that smell like rotting vegetation.

The stench is bad enough out here. In there, it must be nearly overpowering.

APLs 6-8

Guided by the shrieks, you round a corner into a short section of passage. Here there is an almost overpowering stench. Looking ahead, you catch a

glimpse of something multi-colored and bubbling just around the next corner.

Note: At these levels, the two extra fungi are located ten feet down the corridor behind those marked on the map. PCs start one square back so that they have time to react.

ALL APLS

Have PCs make a DC 12 Fortitude saving throws to avoid being sickened for 10 rounds as they approach the first fungus. They must make another save against the second fungus when they enter the room.

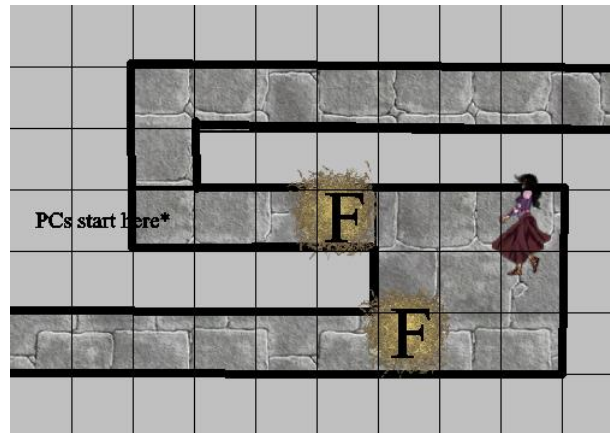

CHAMBER FEATURES

Beyond the overwhelming stench from the fetid fungi, there are no important features in this chamber.

All APLs (non-combatant)

☛ **Mistress Marda:** hp 10 (usually 20); see below.

APL 2

☛ **Fetid Fungus (2):** hp 12 each; Appendix 1.

APL 4

☛ **Advanced fetid fungus (2):** hp 12 each; Appendix 1.

APLs 6-8

☛ **Advanced fetid fungus (4):** hp 12 each; Appendix 1.

A DC 24 Knowledge (arcana) check (once the swarm has been identified) reveals that some mages substitute portions of fetid fungi as components for the *stinking cloud* spell.

Knowledge (nature) checks achieving the following DCs reveal the following:

- **DC 12:** This stinking creature is a fetid fungus. It exudes a sickening gas that reduces fighting effectiveness.

- **DC 17:** Fungi this large can engulf their opponents in the same way a swarm can – and inflict acid damage once they have done so.
- **DC 22:** Fungi produce acid that corrodes whatever touches it, and are invulnerable to acid.
- **DC 27:** Fungi are vulnerable to fire, illusions and other visual effects, and have all the usual plant immunities.
- **DC 32:** Fungi are blind but possess blind sight. When they are killed, they explode in a spray of acid.

APL 4: Increase the DCs above by +2, and note that these fungi seem to be a larger than normal.

APLs 6-8: Increase the listed DCs by +4 and note that these fungi seem to be bigger than those they've heard of.

Tactics: The fungi have pursued Mistress Marda into this chamber. They cannot attack or engulf her – yet, but consider her prey and won't give up the chase. If other, more accessible targets present themselves, the fungi are more than willing to be distracted. Once Mistress Marda's *repulsion* runs out, the nearest fungi approaches 5 ft. closer in the first round, and engulfs her in the second.

Note: From APL 4 upwards, the fungi are squeezing to fit down the corridor, and prefer to use their engulf ability on opponents. They can engulf as many creatures as fit in their space.

Mistress Marda: has run out of spells, and only has 4 rounds remaining before her *repulsion* spell runs out. One round after that the fungi register the fact they can now approach her.

MISTRESS MARDA

Attitude: Helpful (PH 72).

What Mistress Marda Knows: Mistress Marda was wrapping the tapestry for the display when her fingers brushed the leaves on the tapestry. Immediately, she found herself pulled through by dark faeries, shaedlings, and worse before being dumped in this maze. The fungi picked up her trail on the first night, and she's been running from them ever since. She thought she'd outwitted them and had actually had a decent night's sleep, but the little stinkers found her about an hour ago and have been on her trail ever since. If she'd only had her spellbook with her – they'd have had another think coming!! She does, if asked, know Wizard Shamri, and is nearly reduced to tears to know that he is both safe and enquiring after her well-being.

☞ **Mistress Marda:** female human wizard 11.

DEVELOPMENT

If the PCs defeat the fungi in time to rescue Mistress Marda continue to the next encounter as appropriate. They receive the Rescued Marda AR Award.

If the PCs defeat the fungi but fail to rescue Mistress Marda continue on to the next encounter as appropriate. They do not receive the Rescued Marda AR Award unless they retrieve her body and pay for her *true resurrection*.

3C SEEKING CLARIFICATION (OPTIONAL)

This corridor contains a gelatinous cube that has so far frustrated all efforts of the shaedlings to destroy it. To continue down the corridor, the PCs must either avoid it, using the secret door, or defeat it.

A skeleton stands not ten feet away. As it begins to move towards you, you notice that it seems to glide above the floor.

Have the PCs make a DC 12 Spot check. If they are successful, read:

The skeleton appears to be gliding because its feet aren't actually touching the ground. As a matter of fact, its feet aren't really touching its leg bones, nor do its hands appear attached to its arms, or the partially dissolved weapon shimmering above its head.

If one or more of the PCs beat a DC 15 Spot check, continue:

Now that you've noticed the strangeness of the skeleton, you can see that it stands, suspended, in a nearly transparent mass that takes up the entire corridor.

All APLs

☞ **Gelatinous Cube (1):** hp 54; Appendix 1.

A Knowledge (dungeoneering) check reveals the following:

- **DC 14:** This is a gelatinous cube. It attacks using either pseudopods or by engulfing its prey.
- **DC 19:** The cube's attacks cause acid damage to everything but stone and metal.
- **DC 24:** If hit by its pseudopods or if engulfed, you could become paralyzed.
- **DC 29:** The cube is immune to electricity

DEVELOPMENT

If the PCs defeat the cube they are able to progress down the corridor. Go to the next appropriate encounter.

If there was no cube, the corridor is empty. Go the next appropriate encounter.

3D HOME OF THE SWARM (OPTIONAL)

PCs must either defeat, or escapes the swarm that lives in this room. Read:

The scent of flowers, and the low hum of pollen-collecting insects hit you as you step through the door.

A profusion of color and shapes greets you as plants festoon every part of this chamber. Vines hang from the ceiling, ferns and orchids grow from crevices in the crystal, and flowering plants the floor, growing under small dense bushes near the wall's edge and out into the open center of the room.

Off to your right grows a patch of bright red blooms. Off to your left yellows, blues and pinks predominate. There is a doorway diagonally opposite you.

APL 2

From behind a dense clump of vines and flowers a large, solitary and angry bumblebee emerges.

APL 4

From under your feet small creatures hop away in alarm, taking flight to coalesce in a dense, swirling storm of insects that turns and charges towards you.

APLs 6-8

Have the PCs attempt a DC 15 Spot check. If they are successful, read:

It takes you a minute to realize there's a gauntleted hand sticking out from under the red flowers, and that the faint stench of death hangs in air. As you notice this, the blossoms shudder as if blown by a strong breeze and lift into the air before swooping toward you.

PCs failing the Spot check get almost no warning. As they approach the doorway, read:



You are only a few feet from the doorway when the red blossoms shudder, as though ruffled by a strong breeze. Then they lift into the air and swoop towards you.

APL 2

➤ Giant Bee (1): hp 13; MM 284.

APL 4

➤ Locust Swarm (1): hp 21; MM 238.

APLs 6-8

➤ Dread Blossom Swarm (1): hp 45; Appendix 1.

The PCs may attempt to make Knowledge (nature) check to determine what they face:

- **APL 2 (DC 13):** This is a giant bee and it is exactly like its smaller cousin, right down to the poisonous stinger.
- **APL 4 (DC 16):** This is a locust swarm. It is immune to weapon damage and individually targeted attacks.
- **APLs 6-8 (DC 17):** That bunch of flowers is a dread blossom swarm, which exudes a deadly airborne poison within 15 feet of itself. The poison causes paralysis.
- **APLs 6-8 (DC 22):** Dread blossoms are blood drinking plants that take only half damage from piercing and slashing weapons.
- **APLs 6-8 (DC 27):** Anyone paralyzed and caught in the swarm loses Constitution as the swarm drains their blood.
- **APL 6-8 (DC 32):** The swarm regenerates but takes normal damage from fire and cold.

CHAMBER FEATURES

The ceiling of this chamber stretches up to 20 feet. Terrain is open, unless PCs are adjacent to the walls.

Undergrowth: Adjacent to the walls only, this terrain increases the DC of Tumble and Move Silently checks by 2 and costs 2 squares of movement to move into. It provides concealment.

DEVELOPMENT

If the PCs defeat their opponent they are able to progress further into the maze. Go to the next appropriate encounter.

If there are no monsters here, the PCs can enjoy this beautiful garden. When they are finished, go the next appropriate encounter.

3E (OPTIONAL)

Huge vines lurk in the dense undergrowth found in this chamber. They guard the entrance to a cell where another of the missing persons has hidden himself.

When PCs approach the entrance to this area, read:

This area reminds you of the jungle tales travelers bring from the south. Vines have worked their way up the walls and along the ceiling, reducing the pink glow to near-twilight. The only thing missing is the sound of birds calling and insects buzzing. It's eerily silent in here.

Have PCs make Spot checks opposed by the plants' Hide checks. If the PCs fail, the nearest plant is able to attack in a surprise round. Read:

Even as eerie as the chamber is, it looks like the plants are the only thing alive in here. How right you are, is proven when a thick vine lashes out at you from a particularly dense clump of bushes.

If the PCs notice the plant, read:

The something that isn't right feeling nags at you, until you notice the way a tendril from the clump of bushy vines ahead has reared back as though it's about to strike.

APL 2

➤ **Assassin Vine (1):** hp 30; MM 20.

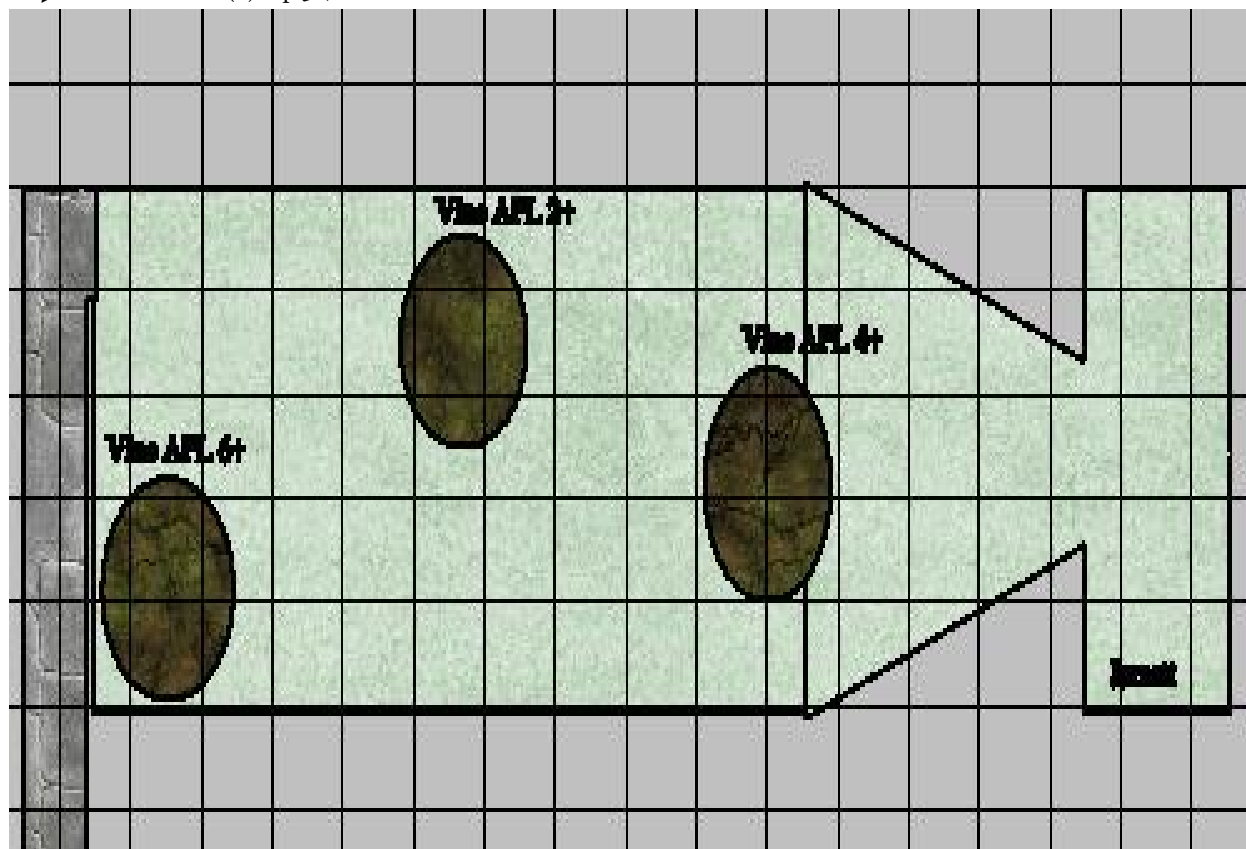

APL 4

➤ **Assassin Vine (2):** hp 30 each; MM 20.

APL 6

➤ **Assassin Vine (3):** hp 30 each; MM 20.

APL 8

➤ **Shambling Mound (3):** hp 60 each; MM 222.

The PCs may attempt to make Knowledge (nature) check to determine what they face:

- **APLs 2-6 (DC 14):** This is an assassin vine – a deadly cluster of creepers that grabs its prey and strangles it, supplying the vine with fertilizer.
- **APLs 2-6 (DC 19):** Although they have only one attack, vines are particularly resilient, being immune to electricity.
- **APLs 2-6 (DC 24):** Vines are also resistant to cold and fire, taking a lot less damage from those forms of attack than others.
- **APL 8 (DC 18):** This is a shambling mound – a deadly cluster of creepers that grabs its prey and strangles it, supplying the vine with fertilizer.
- **APL 8 (DC 23):** Possessing both darkvision and low-light vision, shambling mounds are particularly resilient, being immune to electricity, and resistant to fire.
- **APL 8 (DC 28):** Shambling mounds are not only immune to electricity, but are made stronger by it.

Tactics: The assassin vine/s or shambling mounds strike prey within reach, not using tactics and not sharing. Where this ends up as a tug-of-war in which a PC plays the rope, have the vines involved make an opposed grapple check to see which one ends up with the prey.

CHAMBER FEATURES

Heavy Undergrowth: the profusion of vines and bushes in here means that it is very difficult to traverse the chamber. The following rules for heavy undergrowth apply:

- It costs 4 squares of movement to move into each square.
- It provides concealment with a 30% miss chance.
- It increases the DC of Tumble and Move Silently checks by 5.
- It grants a +5 circumstance bonus to Hide checks.
- Running and charging are impossible.

Lighting (APLs 2-6): Even though the lighting levels aren't quite as bright as those in other areas of this complex, they don't quite qualify as shadowy.

Lighting (APL 8): The undergrowth and vines grow so densely, that the lighting is reduced to shadowy illumination and the following conditions apply:

Creatures within this area have concealment, granting a 20% miss chance. Creatures may make a Hide check to be concealed. This illumination adds +1 to the EL of the encounter.

DEVELOPMENT

The PCs defeat their opponent/s and are able to progress further into the maze. PCs may find and rescue Jarrett from the next chamber. After rescuing him, they may wish to talk to him. (See below.)

If the optional encounter was not run, there were no opponents here, just a beautiful garden. PCs may find and rescue Jarrett from the next chamber. After rescuing him, they may wish to talk to him. (See below.)

JARRETT

Attitude: Friendly (PH 72); helpful, if PCs rescued him.

What Jarrett Knows: Jarrett has developed a nearly-irrational fear of the vines. He claims they tried to kill him. He was 'only looking' at the tapestry (okay, he was touching it, but he wasn't really going to take it – well, not yet anyway). He had a partner in the gallery – Samael; did you find him? He doesn't know a way out of the maze and begs to tag along with PCs. He also asks that he not be handed over to the Watch. After all, hasn't he been punished enough?

♣ **Jarrett:** male human sorcerer 2/rogue 4

3F: THREE RIDDLES

In this encounter, PCs must work out the answer for three riddles and then drop the named item into a slot in order for the door to open. Alternatively, they can just hack their way through.

This chamber is, surprisingly, uninhabited and plant free. The walls are still of the same pink crystal, and the floor is on the same gray stone, but there is nothing of the profusion of plants that you have seen elsewhere.

The first things of note are the four great pots, one standing in each corner of the room, and each one containing a single exotic orchid surrounded by blue stones.

The second thing of note is the far wall. Uninhabited this chamber might be, but certainly not undecorated. That entire wall is covered in carvings of every kind of insect imaginable, and many exotic plants. It looks a lot like the tapestry.

Set into the wall are three slots, above each of which, is a plaque.

There are a number of things the PCs may wish to do:

Look for Secret Doors: PCs succeeding on a DC 20 Search check discover the following:

As you suspected, there is a door behind the ornately-carved wall. It appears to be locked, though.

Reading the Plaques and Solving the Riddle: The plaque on the far left reads:

It opens paths often closed. It is earned not bought, not often sold. It closes eyes and opens doors, is prized by rich men and prized by poor. Insert your answer here.

The plaque in the middle reads as follows:

Cuts like a knife, Stings like a whip, Can soothe like honey, or let poison drip. Insert your answer here.

The plaque on the far right reads as follows:

Scarcely does the father appear, than the son rises into the sky. Insert either one here.

The answers to the riddles are:

The plaque on the far left: gold

The plaque in the middle: tongue

The plaque on the far right: fire (father) or smoke (son)

To open the door, the PCs only need to drop the item named in the answer, through the slot. The plaque in the middle will accept a flower from one of the orchids in the pots as a correct answer. Otherwise, PCs have to work out an alternative.

Don't let them get too bogged down here. If they cannot work out how to get a tongue to put in the center slot and they have rescued Mistress Marda, she identifies, and suggests using, the flowers.

Breaking Down the Wall: The wall is quite tough (3 ft. thick; hardness 10; hp 500; AC 5; Break DC 50).

Identify the Flowers: PCs making a DC 22 Knowledge (nature), DC 20 Heal or Knowledge (arcana), or DC 27 Bardic Knowledge check recognize the potted plants as a variety of orchids known as Dragon's Tongue Lilies.

DEVELOPMENT

If the PCs solve the riddles (with or without Marda's help), or break down the crystal wall (making Mistress Marda cry for its loss), they can progress to the next encounter.

Passing through the door, they come across the following:

A woman of middle years huddles against the wall on the other side of the door. Hearing movement from your direction, she startles sideways, and looks towards you.

"Oh thank the gods," she exclaims, in hushed tones. "Maybe you can save me."

Ariana

Ariana's Attitude: Helpful (PH 72)

What Ariana Knows: Ariana is a curator working in the Guild of Wizardry. She was tasked with looking over the tapestries to both value them and see if they were in need of repair. She was inspecting the Mistress's tapestry when she noticed what might have been a loose thread, or a bit of fluff and, no sooner had her hands touched its surface, than dark fingers reached out and clasped her around the wrists. She managed to shout for help only once, before the dark sprites dragged her through. They dumped her here, laughing at her screams, and praying that she would find her way to the center with speed and the blessing of their dark god. She knows nothing about the riddle wall, having remained mostly in this tunnel, because of the giant beetles in the next chamber. (Scary creatures with giant, glowing, red eyes) She did brave them once, though, when she had a sudden rush of nerves and knew she couldn't stay in the corridor. It was a good thing, too. No sooner had she hidden amongst the mushrooms, than a terrible stench filled the air, and some 'stinking undead things' passed through the wall. That was why she had startled so when the PCs came through. She had been asleep and thought more horrors were coming and that she had no time to hide. What were they? The gods know, but I don't. They passed by not long ago. I don't know how you could have missed them.

I didn't get a really good look at them; too busy hiding. Can you help get me out of here?

🐞 **Ariana:** female human expert (weaver) 7.

Once the PCs have decided what to do next, proceed to the appropriate encounter.

3G: FIRE BEETLES

The PCs must either avoid the usually peaceful fire beetles inhabiting this cavern, or defeat them.

If the PCs approach the entrance to this cavern quietly, read:

This cavern is full of fungi, but there are hints that these mushrooms are well-cared-for. Clear paths weave between them, and dead plant material has been laid carefully at their bases.

The 'gardeners' are indeed giant beetles with glowing red eyes, and they are gathered not far from where you are standing. They look like they might be sleeping.

If the PCs make noise as they approach the cave, read:

This cavern is full of fungi, but there are hints that these mushrooms are well-cared-for. Clear paths weave between them, and dead plant material has been laid carefully at their bases.

The 'gardeners' are indeed giant beetles with glowing red behinds, and they are staring directly you, taking defensive postures between you and the mushrooms, and clattering their mandibles in a threatening manner..

All APLs

🐞 **Giant fire beetles (3):** hp 4; MM 285.

The PCs may make a Knowledge (nature) check to identify the beetles:

- **DC 11:** These are fire beetles. They are usually nocturnal and have no special qualities or attacks, beyond the fact that they are a type of vermin, and have a nasty bite.
- **DC 16:** The glands above their dark beetle eyes, glow red, and will continue to glow for a few days after being removed from the beetle.

Chamber Features

Trees: Some of the larger mushroom provide the same benefits and obstacles as trees (DMG 87). These have been marked on the tactical map as circles.

Mushroom: 2 ft. thick; hardness 2; hp 60; AC 2; Break DC 20.

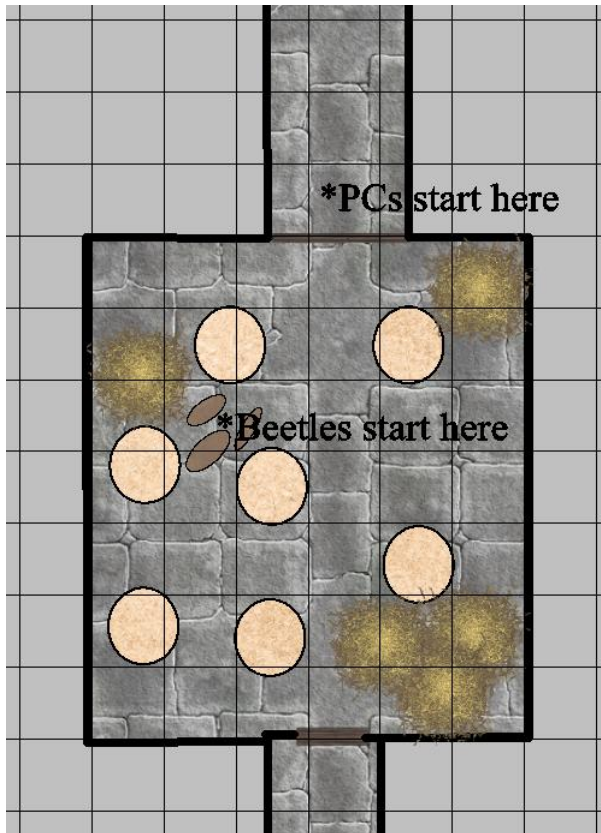

Lighting: Lighting is normal here, if still somewhat pink.

Footing: The footing is stone and unimpeded, unless PCs insist on standing in the compost piled around the smaller mushrooms' bases. The composted areas are represented by the blotches on the map and count as difficult terrain.

DEVELOPMENT

After defeating or working their way around the fire beetles, the PCs can progress to the next encounter.

3H: INCABULOS' MINIONS

Incabulos' minions have made it thus far, and are preparing to make their way down to the harpoon spider lair.

If the PCs make a lot of noise defeating the fire beetles, the minions have set an ambush, otherwise, the PCs may approach undetected. The minions have not heard any noise that might have been made breaking through the wall at Encounter 3F.

As the PCs approach this area, read the following, paraphrasing if they have not received warning of the intruders ahead.

There are more mushrooms and fungi in this room, but it's not nearly as well kept as the chamber before.

When the PCs are in a position to see their foes, read:

These creatures are terrible to look upon. They resemble bloated corpses, and gurgle as they move.

APLs 2-4

☛ Plague Walker (1): hp 42; Appendix 1.

APL 6

☛ Plague Walkers (3): hp 42 each; Appendix 1.

APL 8

☛ Plague Walker (4): hp 42 each; Appendix 1.

The PCs may attempt a Knowledge (religion) check to determine what they face:

- DC 16: This is a plague walker – a form of filthy, disease-spreading undead that attacks with poisonous claws.
- DC 21: When almost totally destroyed, these creatures explode, damaging all within range and nauseating them.
- DC 26: Plague walkers are easier to hit from afar, and its surprisingly easy to do so

Tactics: The plague walkers (when there is more than one of them), fight as a team. Their objective is to get rid of the PCs before the PCs can find and retrieve the amulet.

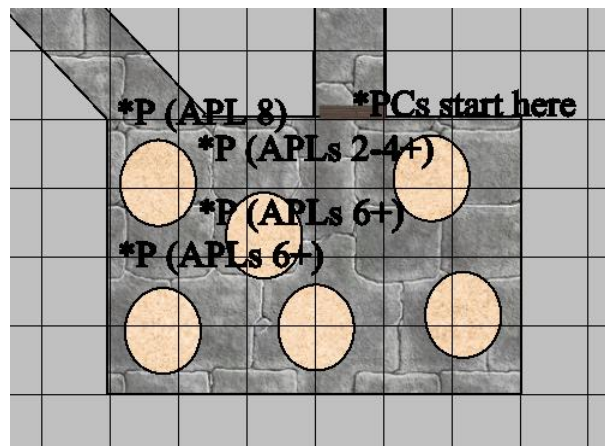

CHAMBER FEATURES

Trees: Some of the larger mushrooms provide the same benefits and obstacles as trees (DMG 87). These have been marked on the tactical map as circles.

Mushroom: 2 ft. thick; hardness 2; hp 60; AC 2; Break DC 20.

Lighting: The lighting is normal here, if still somewhat pink.

Footing: The floor is of stone and is unimpeded.

DEVELOPMENT

Once the plague walkers have been defeated, the PCs can proceed to the final encounter.

3I: SPIDER GOD

The PCs must defeat the harpoon spider to retrieve the amulet and work out how to return to the City of Greyhawk. When they reach the entrance to the spider's lair, read:

This is it, alright – the center of the maze and, home of the shaedlings' god'. A hand-worked crystal spire rises up in the center of this room, and the ceiling climbs to a steep point beyond it. This is the crystal spire you glimpsed through the foliage.

Have the PCs make Spot checks opposed by the spider's Hide check. If they see the spider, read:

You notice a leg - bright red, covered in spines and about as round as a small tree – hanging down from the top of a pillar. It leads to the head of one of the biggest spiders you have seen – and the monster is looking right back.

If they fail the Spot check, the spider leaps out getting a surprise round of actions before they can react.

APL 2

👉 **Harpoon Spider** (1): hp 47; Appendix 1.

APL 4

👉 **Advanced Harpoon Spider** (1): hp 95; Appendix 1.

APL 6

👉 **Advanced Harpoon Spider** (1): hp 135; Appendix 1.

APL 8

👉 **Advanced Dread Harpoon Spider** (1): hp 138; Appendix 1.

The PCs may make a Knowledge (nature) check to identify what they face:

- **DC 15:** This is a harpoon spider. It is well-defended by the spines covering its flesh and does not weave webs.

- **DC 21:** It is called a harpoon spider because it can shoot its fangs at prey like a harpoon, impaling them and reeling them in. It is also poisonous.

Tactics: The spider works to kill as many PCs in as short amount of time as it can. It does not skewer any on its spikes unless the entire party is down, or has fled leaving a member behind.

CHAMBER FEATURES

Tree: The pillar counts as a very large tree. PCs can occupy partial squares on its edge to receive the same benefits as a tree would provide (a +2 bonus to AC, and a +1 bonus on Reflex saves. PCs cannot occupy squares completely filled with pillar.

Pillar: 20 ft. thick; hardness 10; hp 900; AC 5; Break DC 50.

Lighting: Normal in this chamber – if still pink from passing through the crystal.

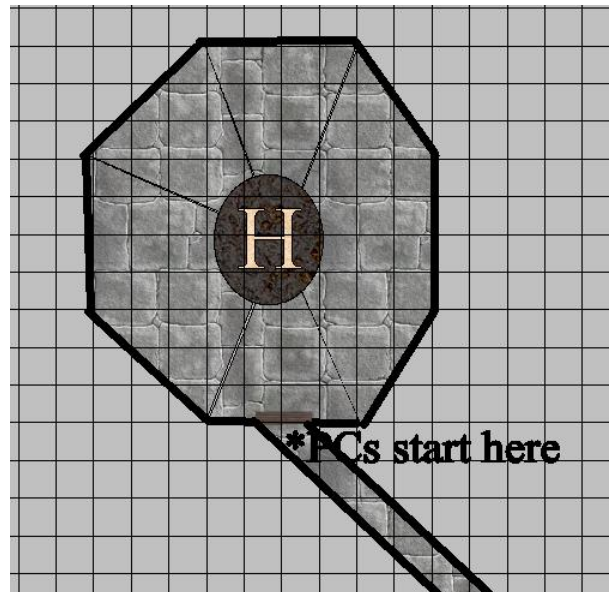

Treasure: There is strange amulet tangled amongst the spider's spines. It is a wash of shifting colors and carved with the images of a myriad of insects. It vibrates as though it is full of wasps, but appears to be solid and weighs heavily in your hand.

DEVELOPMENTS

After defeating the spider, the PCs are joined by any NPCs they may have ordered to stay away from the battle. The PCs may also like to search the chamber for secret doors or treasure. They find none of the latter, but closer inspection of the pillar reveals the following:

A softly glowing hollow can be seen set in one side of the crystal pillar. It is the only thing of significance that you can find here. The hollow is empty.

If *detect magic* is used on the hollow, it glows with the aura of conjuration magic. Its purpose cannot be discerned unless one of the PCs reaches into the hollow to investigate it by touch. If they do this, read:

The hollow starts to glow, increasing in intensity until it is as though you are looking at a pillar of light pink fire, but the temperature of the stone and the chamber do not change. The light spreads out from the pillar, engulfing everyone in the room and stealing your sight for a moment. When it fades, and you can see again, you are standing in the hall where the tapestries are on display.

You are standing, in fact, in front of a tapestry that has been firmly covered in a tightly tied black cloth. Around you, an alarm signals that there are intruders on this level of the Guild of Wizardry.

Looking around yourselves, as doors at either end of the hall burst open, you realize that you are the intruders, and that the chief wizard, at least, is glad to see you as he hurries forward in front of the guards.

Go to the Conclusion.

NOTE: If the PCs are reluctant to stick their arms in the hollow, one of the NPCs does it, or the amulet reacts to the hollow by pulling towards it.

CONCLUSION

THE NPCS

If the PCs Rescued Mistress Marda, read:

The Wizard Shamri is almost beside himself when he learns that you have returned Mistress Marda to him. He greets her with an all-enveloping hug, and then drops to one knee before her.

"I thought I would never see you again," he declares, "and it made me realize that some things are more precious than presenting a 'proper' front."

His words bring gasps from the mages around you. He ignores them and continues, "I was once your apprentice, but I am now a wizard in my own right. Next to my love of magic is my love for you and neither is complete without the other. Will you accept me as your groom?"

Blushing at his words, and with tears of joy sparkling in her eyes, Mistress Marda accepts. You, of course, now have a wedding to attend.

PCs receive the Rescued Mistress Marda AR Award.

If the PCs Rescued Samael and/or Jerrit, read:

Shortly after their return, Samael and Jerrit slip silently away. Their disappearance causes raised eyebrows and knowing nods amongst the wizards, but no one speaks against them.

Some time later, you awake in your lodgings to find that you are not alone. Samael (and Jerrit) stand

at the foot of your bed. They whisper their thanks to you and promise you access to many items as a token of their gratitude.

The PCs receive the Rescued Samael/Jerrit AR Award.

If the PCs Rescued Ariane, read:

Ariane's return was met with relief and muted joy. As well as being a very nice person, she is, apparently, one of the best seamstresses and weavers the Guild of Wizardry has available and her skills are nigh on irreplaceable. Although low-key, her Safe Return Party, is hosted by some of the more skilled crafters and wizards Greyhawk has to offer and they wish to show their appreciation for her safe return, of course!

The PCs receive the Rescued Ariane AR Award.

THE AMULET

PCs wanting to identify the amulet, are eventually directed to directed to Sister Kuranyie, a priestess of Bralm recently arrived in the city looking for news of the amulet's location.

The house rented by Sister Kuranyie is a quiet place, set in a walled compound amid extensive gardens somewhat reminiscent of the world beyond the tapestry.

It seems that you're expected. The compound's gate stands wide open and within a woman sitting at a table amid the flowers waves you in.

When you reach the table, a tall woman with dark blond hair looks up and greets you. Her Suel features are stern, but friendly, and she extends her hands in greeting.

"I am Sister Kuranyie; welcome to my temporary home," she says. "I understand you wish something identified."

Let the PCs respond. While the lady answers no questions here, she does usher them inside to a small sitting room in which is a table and a casket. Read:

The room you are taken to looks like a small sitting room. Situated in the middle of a circle of large, soft chairs scattered with cushions, is a low wooden table, in the center of which sits a casket. Gesturing for you to join her, the priestess sits.

"May I see it?" she asks. "It will be much easier to identify that way."

Allow the PCs to respond. They can hang onto the amulet if it makes them feel better, but the lady insists that she needs to inspect the carvings closely if she is to be able to identify it accurately. Once she has been able to inspect it, she hands it back and tells them the following:

"It seems my excitement is warranted," the lady says, handing the amulet back to you. Her voice trembles

slightly. "The object is what I hoped it would be, and that means I owe you an explanation.

Firstly, it is an artifact of Bralm, stolen long ago by Zagig in attempt to trap our lady and steal her power for himself." Her voice shakes with what might be suppressed anger, and her eyes grow dark. With an effort, she shakes the fury away, "We did not pursue it, since our lady does not need the object any longer, although it strengthens her grip on her realm, and affirms her right to rule over the littlest creatures that aid us.

"However, content as we may have been for our lady to retain her freedom, and leave the amulet where it was, my priesthood recently learned that agents of Incabulos were moving amongst the ruins. While we pondered why, we worried that a gate into the demi-plane that held the amulet had been found.

"And our worries were well-founded. We were about to seek out adventurers to retrieve the amulet, when you travelled to the demi-plane yourselves.

"Warned to patience by the goddess, we waited for your return, willing to trust in your sense of honor and offer the reward I would have offered for its retrieval. Will you be willing to return the amulet to me so that we may return it to our goddess's hands?"

Let the PCs respond to this. If they ask about the reward, she promises that her temple will provide them Core access to the following: *swarmguard* armor enhancement, *swarmstrike* weapon enhancement (both DS), *rod of healing*, *rod of swarming insects*, and the spell *summon pest swarm* (CS) and the blessing of Bralm (although who knows what form the goddess's blessing will take), as well as the monetary repayment mentioned below. They are not offended by the PCs' request, as, after all, they suggested the reward themselves. If the PCs accept, read:

The woman's face blossoms into a smile. "We thank you," she says, and then, "I thank you," as she disappears into a shimmering swarm of dragonflies that disappears in a fading column of light.

(PCs may note in the notes section of the adventure that they have met the prerequisite for the Prestige Class Contemplative of Bralm).

If the PCs refuse, read:

For a moment, the woman stills. "Are you sure?" she asks, and her voice holds the edge of sussurating insects's wings.

PCs may interrupt and change their minds here. It's their only chance.

"Then so be it," the woman says. "I am not a thief or a murderer. You may go."

PCs returning the amulet have earned the Favor of the Temple of Bralm AR Item. PCs refusing have earned the Curse of Bralm AR Item.

GOLD FOR THIS ADVENTURE

The gold for this adventure comes from the rewards given for those the PCs rescue, in addition to payments made by various organizations and individuals for information on the strange demi-plane they have visited. It is divided as follows (with extra being paid for bringing each NPC through the more dangerous environment):

Rescuing Mistress Marda

- APL 2: 70 gp (105 gp if optional encounters played)
- APL 4: 100 gp (150 gp if optional encounters played)
- APL 6: 140 gp (210 gp if optional encounters played)
- APL 8: 200 gp (300 gp if optional encounters played)

Rescuing Samael

- APL 2: 70 gp (105 gp if optional encounters played)
- APL 4: 100 gp (150 gp if optional encounters played)
- APL 6: 140 gp (210 gp if optional encounters played)
- APL 8: 200 gp (300 gp if optional encounters played)

Rescuing Jerritt

- APL 2: 70 gp (105 gp if optional encounters played)
- APL 4: 100 gp (150 gp if optional encounters played)
- APL 6: 140 gp (210 gp if optional encounters played)
- APL 8: 200 gp (300 gp if optional encounters played)

Rescuing Ariana

- APL 2: 70 gp (105 gp if optional encounters played)
- APL 4: 100 gp (150 gp if optional encounters played)
- APL 6: 140 gp (210 gp if optional encounters played)
- APL 8: 200 gp (300 gp if optional encounters played)

Returning the Amulet

- APL 2: 100 gp (150 gp if optional encounters played)
- APL 4: 150 gp (225 gp if optional encounters played)
- APL 6: 200 gp (300 gp if optional encounters played)
- APL 8: 300 gp (450 gp if optional encounters played)

Sharing Information on the Demi-Plane

- APL 2: 70 gp (105 gp if optional encounters played)
- APL 4: 100 gp (150 gp if optional encounters played)
- APL 6: 140 gp (210 gp if optional encounters played)
- APL 8: 200 gp (300 gp if optional encounters played)

AFFILIATION REWARDS

Now is the time to determine how many affiliation points each PC gained for their given affiliations. Record each PC's gain (or loss) on the Affiliations Score Gained/Lost AR item. PCs can gain the following points:

The Guild of Wizardry

- 1 point for rescuing the Mistress Marda
- 1 point for rescuing Ariane

Merchants and Traders Union

- 1 point for rescuing Ariane

Mercenaries' Guild

- 1 point for discovering the dangers of the tapestry

Cartographers' Guild

- 1 point for mapping out the maze.

Thieves' Guild

- 1 point for rescuing Samael
- 1 point for rescuing Jerritt

Nightwatchmen

- 1 point for discovering the dangers of the tapestry.

Religious Organizations

- 1 point for recovering the *amulet of Bralm* and returning it.
- -1 point for recovering the *amulet of Bralm* and refusing to return it.

EXPERIENCE POINT SUMMARY

To award experience for this adventure, add up the values for the objectives accomplished. Then assign the experience award. Award the total value (objectives plus roleplaying) to each character.

1: Through the Looking Glass

Defeat the shaedlings in battle

APL 2	150 XP
APL 4	180 XP
APL 6	210 XP
APL 8	240 XP

3A: Watery Demise

Defeat the Swamp Strider Swarm in combat, OR cross the pit and rescue Samael the rogue from the pillar-top while avoiding the swarm (50% xp for crossing; 50% for rescuing Samael)

APLs 4-6	150 XP
APL 8	210 XP

3B: Kicking up a Stink

Defeat the fetid fungi in battle

APL 2	60 XP
APL 4	120 XP
APLs 6-8	180 XP

3G: Fire Beetles

Pass through this chamber, defeating or avoiding the fire beetle inhabitants.

APL 2	30 XP
APLs 4-8 defeating the fire beetles is not a challenge at these APLs and earns no xp award.	

3H: Splattered

Defeat Incabulos's minions in battle

APLs 2-4	90 XP
APL 6	180 XP
APL 8	210 XP

3I: Home Sweet Home

Defeat the harpoon spider and go home

APL 2	120 XP
APL 4	150 XP
APL 6	180 XP
APL 8	210 XP

Total Possible Experience

APL 2	450 XP
APL 4	690 XP
APL 6	900 XP
APL 8	1,050 XP

Total Experience to be Awarded

APL 2	450 XP
APL 4	675 XP

APL 6	900 XP
APL 8	1,125 XP

OPTIONAL ENCOUNTERS

3C: Seeking Clarification (Optional)

Defeat the gelatinous cube in battle

All APLs	90 XP
----------	-------

3D: Home of the Swarm (Optional)

Pass through the chamber, defeating or avoiding, its inhabitants.

APL 2	30 XP
APL 4	90 XP
APLs 6-8	180 XP

3E: Viniculture (Optional)

Defeat the vine/s and rescue Jarett

APL 2	90 XP
APL 4	150 XP
APL 6	180 XP
APL 8	300 XP

Total Possible Experience

APL 2	210 XP
APL 4	330 XP
APL 6	450 XP
APL 8	570 XP

Total Experience to be Awarded

APL 2	210 XP
APL 4	330 XP
APL 6	450 XP
APL 8	560 XP

TREASURE SUMMARY

During an adventure, characters encounter treasure, usually finding it in the possession of their foes. Every encounter that features treasure has a "treasure" section within the encounter description, giving information about the loot, coins, and magic items that make up the encounter's treasure.

The loot total is the number of gold pieces each character gains if the foes are plundered of all their earthly possessions. Looting the bodies takes at least 10 minutes per every 5 enemies, and if the characters cannot take the time to loot the bodies, they do not gain this gold. If you feel it is reasonable that characters can go back to loot the bodies, and those bodies are there (i.e., not carted off by dungeon scavengers, removed from the scene by the local watch, and so on), characters may return to retrieve loot. If the characters do not loot the body, the gold piece value for the loot is subtracted from the encounter totals given below.

The coin total is the number of gold pieces each character gains if they take the coin available. A normal adventuring party can usually gather this wealth in a round or so. If for some reason, they pass up this treasure,

the coin total is subtracted from the encounter totals given below.

Next, the magic items are listed. Magic item treasure is the hardest to adjudicate, because they are varied and because characters may want to use them during the adventure. Many times characters must cast *identify*, *analyze dweomer* or similar spell to determine what the item does and how to activate it. Other times they may attempt to use the item blindly. If the magic item is consumable (a potion, scroll, magic bolts, etc.) and the item is used before the end of the adventure, its total is subtracted from the adventure totals below.

Once you have subtracted the value for unclaimed treasure from each encounter add it up and that is the number of gold pieces a characters total and coin value increase at the end of the adventure. Write the total in the GP Gained field of the adventure certificate.

Loot = Looted gear from enemy; Coin = Coin, Gems, Jewelry, and other valuables; Magic = Magic Items.

Treasure Cap

APL 2: 450gp; APL 4: 650 gp; APL 6: 900 gp; APL 8: 1,300 gp.

Total Possible Treasure

APL 2: 450 gp; APL 4: 650 gp; APL 6: 900 gp; APL 8: 1,300 gp.

OPTIONAL ENCOUNTERS

Treasure Cap

APL 2: 225 gp; APL 4: 325 gp; APL 6: 450 gp; APL 8: 650 gp.

Total Possible Treasure

APL 2: 225 gp; APL 4: 325 gp; APL 6: 450 gp; APL 8: 650 gp.

ADVENTURE RECORD ITEMS

☛ **Affiliation Score Gained/Lost:** by this PC with the _____ Greyhawk affiliation was # __ points. If multiple allegiance, add extra in notes section.

☛ **Rescued Mistress Marda:** You are formally invited to her wedding to the Wizard Shamri. The couple also offer Core access to the *invulnerability* and *spell resistance +2 to +3* armor enhancements, the *spell storing* weapon enhancement, a *minor ring of spell storing* and a *ring of wizardry I*; They also offer you training in the following feats: *Strong Stomach (Cityscape)*, *Favored Magic Foe (CM)* and the *buzzing bee (SpC)* spell. You must meet all prerequisites and pay all normal costs associated with each.

☛ **Rescued Samael/Jerritt:** for which you are rewarded with Core access to the following: *Armor Enh.: glamered, shadow, improved shadow, silent moves, improved silent moves*; Weapons: *luck blade (o wishes), sword of subtlety*; Items:

elixir of sneaking, elixir of hiding, ring of evasion; *lock slick (Dungeonscape)*; Spells: *detect weaponry, false peacebond, secret weapon (Cityscape)*; Feat: *Combat Tinkering, Quick Reconnoiter, Trap Engineer, Trap Sensitivity (all Dungeonscape)*; Prestige Class: *Trapsmith (Dungeonscape)*. You must meet all prerequisites and pay all normal costs associated with each.

☛ **Rescued Ariane:** You attend her exclusive Safe Return party and are granted Core access to the following: *bolt shirt (MIC)*; *cloak of arachnida, robe of blending, robe of scintillating colors, robe of useful items, vest of escape, and druid's vestment*. You must meet all prerequisites and pay all normal costs associated with each.

☛ **Favor of the Temple of Bralm:** For returning the amulet, you receive Core access to the following: *swarmguard (Dungeonscape)* armor enhancement, *swarmstrike (Dungeonscape)* weapon enhancement, *rod of healing, rod of swarming insects* and the *summon pest swarm spell (Cityscape)*. You must meet all prerequisites and pay all normal costs associated with each. In addition, you are immune to the next three swarms you meet; cross each off as you encounter it ☐ ☐ ☐.

☛ **Curse of Bralm:** You refused to return the amulet, but it disappeared from your possession shortly afterwards. All you can remember of that night is the sound of thousands of insect wings. With its disappearance the amulet left a strange legacy. For the next five adventures, whenever you are facing a situation that involves combat or concentration, you must make a DC 15 Fortitude save or be nauseated for 1 round. In addition, if you fail, you must make a Concentration check for spellcasting as though under the influence of a swarm.

ITEM ACCESS

None.

APPENDIX 1: ALL APLS

1: THROUGH THE LOOKING GLASS

ELITE SHAEDLING CR 3

Male shaedling*

**Monster Manual V* 148

CE Medium fey

Init +6; **Senses** darkvision 60 ft., low-light vision; Listen +9, Spot +9

Languages Common, Sylvan

AC 15, touch 14, flat-footed 11 (+4 Dex, +1 shield)

hp 30 (4 HD); **DR** 5/cold iron

Fort +5, **Ref** +10, **Will** +6

Speed 30 ft. (6 squares), fly 60 ft. (good)

Melee spiked chain +8 (2d4)

Ranged bolas +8 (1d4 non-lethal)

Ranged javelin +8 (1d6)

Space 5 ft.; **Reach** 5 ft. (10 ft. with spiked chain)

Base Atk +2; **Grp** +2

Atk Options Combat Reflexes, Point Blank Shot, shadow gossamer

Special Actions sleeping curse, wall of darkness

Abilities Str 10, Dex 23, Con 18, Int 15, Wis 14, Cha 14

Feats Combat Reflexes, Point Blank Shot, Weapon Finesse

Skills Appraise +2 (+4 weapons), Bluff +9, Craft (weaponsmithing) +9, Diplomacy +4, Escape Artist +12 (+14 ropes), Hide +13, Intimidate +5, Listen +9, Move Silently +13, Spot +9, Use Rope +15,

Possessions combat gear plus bolas, javelin (6), shadow gossamer buckler, spiked chain

Shadow Gossamer (Ex) As a swift action, a shaedling can generate a 15-pound or lighter item out of shadow gossamer, and it usually crafts a weapon just before attacking. A shaedling is proficient with any weapon it creates from shadow gossamer, and such weapons have a range increment 10 feet longer than usual. Shields constructed of this substance have their armor check penalty lessened by 1. Shadow gossamer implements dissipate to nothingness if they leave the hands of a shaedling for longer than 1 round.

Sleeping Curse (Su) Once per day, a shaedling can target an opponent within 30 feet with a special javelin of venomous shadow gossamer. A foe struck by this javelin must succeed on a DC 14 fortitude save or fall asleep for 1d6 rounds. A *remove curse* spell ends this effect. The save DC is Charisma-based.

Wall of Darkness (Su) Once per day, a shaedling can generate a wall of darkness up to 30 feet long. The wall blocks line of sight for all creatures except those that have darkvision.

3A: WATERY DEMISE

SWAMP STRIDER SWARM* CR 5

**Monster Manual III* 171

N Diminutive vermin (swarm)

Init +9; **Senses** darkvision 60 ft. wave sense; Listen +0, Spot +4

AC 19, touch 19, flat-footed 14 (+4 size, +5 Dex)

hp 40 (9 HD)

Immune weapon damage, spells that target specific numbers of creatures, mind-affecting spells and abilities, not subject to critical hits or flanking, cannot be tripped, grappled or bull rushed

Fort +6, **Ref** +8, **Will** +3

Weakness spells or effects that affect an area, high winds

Speed 50 ft. (10 squares); water walk

Space 10 ft.; **Reach** 0 ft.

Base Atk +6; **Grp** -

Atk Options distraction, wounding

Abilities Str 1, Dex 20, Con 10, Int —, Wis 10, Cha 8

Feats Improved Initiative^B

Skills Hide +21, Spot +4

Distraction (Ex) Any living creature vulnerable to a swamp strider swarm's damage that begins its turn with a swarm in its square is nauseated for 1 round; a DC 14 Fortitude save negates the effect. Even after a successful save, spellcasting or concentrating on spells within the area of a swarm requires a Concentration check (DC 20 + spell level). Using skills requiring patience and concentration requires a DC 20 Concentration check. The save DC is Constitution-based.

Water Walk (Ex) Swamp striders move as easily across water as on land. This ability functions like the *water walk* spell, except that it is an extraordinary ability, and the swamp strider swarm actually touches the water rather than floating above it. A swamp strider swarm that is submerged will rise to the surface (as per the spell effect), but if it is forced underwater for 5 rounds or more, it must make a DC 15 Fortitude save every round thereafter, or perish.

Wave Sense (Ex) A swamp strider swarm notices and locates any creatures within 30 feet as long as they are in the same body of water as the swarm.

Wounding (Ex) Any living creature damaged by a swamp strider swarm continues to bleed, losing 1 hit point per round thereafter. Multiple wounds do not result in cumulative bleeding loss. The bleeding can be stopped by a DC 10 Heal check or the application of a *cure* spell or some other healing magic.

Skills Swamp striders have a +4 racial bonus on Spot checks. Swamp striders gain a +4 racial bonus on Hide checks when in swamps or wetland terrain.

3C: SEEKING CLARIFICATION

GELATINOUS CUBE

CR 3

N Large ooze

Init -5; **Senses** blindsight 60 ft., Listen -5

Languages -

AC 4, touch 4, flat-footed 4

(-1 size, -5 Dex)

hp 54 (4 HD)

Immune electricity, ooze immunities

Fort +9, **Ref** -4, **Will** -4

Speed 15 ft. (3 squares)

Melee slam +2 (1d6+1d6 acid)

Space 10 ft.; **Reach** 5 ft.

Base Atk +3; **Grp** +7

Atk Options acid, engulf, paralysis

Abilities Str 10, Dex 1, Con 26, Int —, Wis 1, Cha 1

SQ transparent

Acid (Ex) A gelatinous cube's acid does not harm metal or stone.

Engulf (Ex) Although it moves slowly, a gelatinous cube can simply mow down Large or smaller creatures as a standard action. It cannot make a slam attack during a round in which it engulfs. The gelatinous cube merely has to move over the opponents, affecting as many as it can cover. Opponents can make opportunity attacks against the cube, but if they do so, they are not entitled to a saving throw. Those who do not attempt attacks of opportunity, must succeed on a DC 13 Reflex save or be engulfed; on a success, they are pushed back or aside (opponent's choice) as the cube moves forward. Engulfed creatures are subject to the cube's paralysis and acid, and are considered to be grappled and trapped within its body. The save DC is Strength-based and includes a +1 racial bonus.

Paralysis (Ex) A gelatinous cube secretes an anesthetizing slime. A target hit by a cube's melee or engulf attack must succeed on a DC 20 Fortitude save or be paralyzed for 3d6 rounds. The cube can automatically engulf a paralyzed opponent. The save DC is Constitution-based.

Transparent Gelatinous cubes are hard to see, even under ideal conditions, and it takes a DC 15 Spot check to notice one. Creatures who fail to notice a cube and walk into it are automatically engulfed.

3H: SPLATTER

PLAGUE WALKER*

CR 3

**Monster Manual IV* 120

CE Medium undead

Init +2; **Senses** darkvision 60 ft., Listen +10, Spot +1

Languages understand creator's orders

AC 12, touch 8, flat-footed 12

(-2 Dex, +4 natural)

hp 42 (6 HD)

Immune undead immunities

Fort +2, **Ref** +0, **Will** +6

Weakness ranged attacks (bloated target)

Speed 20 ft. (4 squares)

Melee 2 claws +8 each (1d6+4 plus diseased touch)

Base Atk +3; **Grp** +7

Atk Options diseased touch

Special Actions putrid burst

Abilities Str 18, Dex 6, Con —, Int 4, Wis 13, Cha 3

SQ undead traits

Feats Skill Focus (Listen), Toughness, Weapon Focus (claw)

Skills Climb +7, Hide -2, Listen +10, Spot +1,

Diseased Touch (Su) Any living creature struck by a plague walker's claws must succeed on a DC 13 Fortitude save or be overcome with racking pain and nausea, causing that creature to become sickened for 1 minute. The save DC is Constitution-based. Creatures that have immunity to disease are not affected by this ability.

Putrid Burst (Ex) When reduced to one-quarter of its starting hit points or fewer, a plague walker can use a swift action to explode. This burst has a 30-foot radius and deals 3d6 points of damage to everything in the area. All living creatures in the area are nauseated for 1 round; a DC 15 Reflex save halves the damage and negates the nauseated effect. The save DC is Constitution-based and includes a +2 racial bonus.

If reduced to 0 hit points before it can activate its putrid burst, a plague walker simply dissolves into a pile of rotting flesh.

Bloated Target (Ex) The -4 penalty for firing into melee does not apply to ranged attacks made against a plague walker. The penalty does, however, apply to other creatures in melee with it.

3B: KICKING UP A STINK**FETID FUNGUS*****CR 1****Monster Manual V 56*

N Medium plant

Init -1; **Senses** blind, blindsight 60 ft.; Listen +0**Aura** sickening gas (DC 12, 30 ft.)**Languages** —**AC** 13, touch 9, flat-footed 13

(-1 Dex, +4 natural)

hp 12 (2 HD); death throes**Immune** acid, gaze attacks, illusions, plant immunities, visual effects**Fort** +4, **Ref** -1, **Will** +0**Weakness** vulnerability to fire**Speed** 20 ft. (4 squares)**Melee** acid touch +1 (1d6 acid)**Base Atk** +1; **Grp** +1**Atk Options** decomposing slime, engulf**Abilities** Str 11, Dex 8, Con 13, Int 1, Wis 10, Cha 5**SQ** plant traits**Feats** Track**Skills** Hide +2 (+12 in swampy terrain), Listen +0, Survival +2

Sickening Gas (Ex) A fetid fungus's amorphous body is filled with gases given off by decomposing matter. All living creatures within 30 feet of a fetid fungus must succeed on a DC 12 Fortitude save or be sickened for 10 rounds. The save DC is Constitution-based.

Death Throes (Ex) When destroyed, a fetid fungus explodes in a 10-foot-radius burst of corrosive ichor that deals 1d4 points of acid damage (Reflex DC 12 half) to all creatures in the area. The save DC is Constitution-based.

Decomposing Slime (Ex) A fetid fungus's body produces a decomposing slime. Any creature that strikes or touches a fetid fungus with its body, or that grapples a fetid fungus, takes 1 point of acid damage. A creature takes damage from this ability only once per round.

Engulf (Ex) As a standard action, a fetid fungus can envelop creatures of its size or smaller, entrapping them within itself. The fungus simply moves into the opponent's space; any creature whose space it completely covers is subject to the engulf attack. A fungus cannot make a touch attack during a round in which it engulfs. It can engulf as many creatures as can fit in its space.

Opponents can make attacks of opportunity against the fungus, but, if they do so, they are not entitled to a saving throw. Those who do not attempt attacks of opportunity must succeed on a DC 12 reflex save or be engulfed. On a success, a creature moves aside or back (opponent's choice) to move out of the fungus's path. The save DC is Constitution-based. Engulfed creatures are considered to be grappled within the fungus's body, they are subject to its touch attack, and they take 1 point of acid damage per round from its decomposing slime.

Skills Fetid fungi have a +10 racial bonus on Hide checks when in marsh or swamp terrain.

3I: HOME SWEET HOME**HARPOON SPIDER*****CR 4****Monster Manual III 80*

CE Large aberration

Init +4; **Senses** darkvision 120 ft., Listen +1, Spot +7**Languages** Common, Sylvan**AC** 16, touch 13, flat-footed 12; spines

(-1 size, +4 Dex, +3 natural)

hp 47 (5 HD)**Resist** evasion**Immune** vermin immunities, web**Fort** +5, **Ref** +5, **Will** +5**Speed** 40 ft. (8 squares), climb 20 ft.; web movement**Melee** bite +5 (1d8+3 plus poison)**Ranged** 2 fangs +6 each (1d4+1 plus harpooning)**Space** 10 ft.; **Reach** 5 ft.**Base Atk** +3; **Grp** +6**Atk Options** Combat Reflexes, Improved Trip, harpooning, poison**Abilities** Str 17, Dex 19, Con 18, Int 14, Wis 12, Cha 9**Feats** Combat Reflexes, Improved Toughness, Improved Trip^B**Skills** Balance +9, Climb +16, Hide +8, Jump +22, Spot +7, Tumble +11

Harpooning (Ex) As ranged attacks, a harpoon spider can fire one or two of its fangs up to 20 feet (no range increment). The spider can fire at two different targets if it chooses. A successful hit deals 1d4+1 points of damage as the harpoon hooks the flesh of the target and immediately exudes a thick, sticky glue. The spider can reel in a harpoon as a free action; treat this as a trip attack (+10 bonus) against any creature attached to the fang. Failure indicates that the harpoon rips free (and deals another 1d4+1 points of damage to the victim). Success indicates that the victim is pulled off its feet and dragged back to the spider, who can immediately make a free bite attack against the victim. A harpoon spider can only pull a creature smaller than itself in this manner. Attempts to retract a creature of its own size or larger automatically cause the fang to rip free as if the trip attack failed. The glue exuded by the spider's fangs decomposes quickly, and at the end of the spider's turn the fang automatically detaches.

Poison (Ex) Injury, Fortitude DC 16, initial damage 1d6 Dex, secondary damage 2d4 Dex. The save DC is constitution based.

Spines (Ex) Any creature striking a harpoon spider with its body or a handheld weapon, must make a DC 16 Reflex save or take 1d6 points of piercing damage from the spider's spines. (Creatures wielding reach weapons, such as long spears, are not subject to this damage.) The spines also deal an extra 1d6 points of damage on a successful grapple check (much like armor spikes). The save DC is Dexterity-based.

As a full-round action, a harpoon spider can pick up a Medium or smaller helpless creature with its legs and impale the body on its spines, dealing 2d6 points of piercing damage. The spider can carry up to 2 Medium, 8 Small, 32 Tiny, or 128 Diminutive or smaller creatures in this manner. Harpoon spiders often use this method to carry their next meals.

Web Movement (Ex) Although they cannot spin webs themselves, harpoon spiders can climb around and through webs with ease using their climb speed.

They are immune to the effects of the *web* spell

Skills A harpoon spider has a +8 racial bonus on Climb checks and Jump checks, and it can always choose to take 10 on a Climb check, even if rushed or threatened.

3B: KICKING UP A STINK

ADVANCED FETID FUNGUS* CR 2

**Monster Manual V 56*

N Large plant

Init -2; **Senses** blind, blindsight 60 ft.; Listen +0

Aura sickening gas (DC 15; 30 ft.)

Languages —

AC 13, touch 7, flat-footed 15

(-1 size, -2 Dex, +6 natural)

hp 28 (4 HD); death throes

Immune acid, gaze attacks, illusions, plant immunities, visual effects

Fort +5, **Ref** -1, **Will** +1

Weakness vulnerability to fire

Speed 20 ft. (4 squares)

Melee acid touch +7 (1d6+5 acid)

Space 10 ft.; **Reach** 5 ft.

Base Atk +3; **Grp** +12

Atk Options decomposing slime, engulf

Special Actions

Abilities Str 20, Dex 6, Con 17, Int 1, Wis 10, Cha 5

SQ plant traits

Feats Ability Focus (engulf), Track

Skills Hide -1 (+9 in swampy terrain), Listen +0, Survival +2

Sickening Gas (Ex) A fetid fungus's amorphous body is filled with gases given off by decomposing matter. All living creatures within 30 feet of a fetid fungus must succeed on a DC 15 Fortitude save or be sickened for 10 rounds. The save DC is Constitution-based.

Death Throes (Ex) When destroyed, a fetid fungus explodes in a 10-foot-radius burst of corrosive ichor that deals 1d4 points of acid damage (Reflex DC 12 half) to all creatures in the area. The save DC is Constitution-based.

Decomposing Slime (Ex) A fetid fungus's body produces a decomposing slime. Any creature that strikes or touches a fetid fungus with its body, or that grapples a fetid fungus, takes 1 point of acid damage. A creature takes damage from this ability only once per round.

Engulf (Ex) As a standard action, a fetid fungus can envelop creatures of its size or smaller, entrapping them within itself. The fungus simply moves into the opponent's space; any creature whose space it completely covers is subject to the engulf attack. A fungus cannot make a touch attack during a round in which it engulfs. It can engulf as many creatures as can fit in its space. Opponents can make attacks of opportunity against the fungus, but, if they do so, they are not entitled to a saving throw. Those who do not attempt attacks of opportunity must succeed on a DC 14 Reflex save or be engulfed. On a success, a creature moves aside or back (opponent's choice) to move out of the fungus's path. The save DC is Constitution-based. Engulfed creatures are considered to be grappled within the fungus's body, they are subject to its touch

attack, and they take 1 point of acid damage per round from its decomposing slime.

Skills Fetid fungi have a +10 racial bonus on Hide checks when in marsh or swamp terrain.

3I: HOME SWEET HOME

ADVANCED HARPOON SPIDER* CR 5

**Monster Manual III 80*

CE Huge aberration

Init +4; **Senses** darkvision 120 ft., Listen +1, Spot +7

Languages Common, Sylvan

AC 18, touch 12, flat-footed 15; spines

(-2 size, +4 Dex, +6 natural)

hp 95 (9 HD)

Resist evasion

Immune vermin immunities, web

Fort +9, **Ref** +7, **Will** +7

Speed 40 ft. (8 squares), climb 20 ft.; web movement

Melee bite +11 (2d6+7 plus poison)

Ranged 2 fangs +8 each (1d6+1 plus harpooning)

Space 10 ft.; **Reach** 5 ft.

Base Atk +6; **Grp** +21

Atk Options Combat Reflexes, Improved Trip, Power Attack, harpooning, poison

Abilities Str 25, Dex 18, Con 22, Int 14, Wis 12, Cha 9

Feats Ability Focus (poison), Combat Reflexes,

Improved Toughness, Improved Trip^B, Power Attack

Skills Balance +9, Climb +27, Hide +8, Jump +31, Spot +7, Tumble +11

Harpooning (Ex) As ranged attacks, a dreadharpoon spider can fire one or two of its fangs up to 20 feet (no range increment). The spider can fire at two different targets if it chooses. A successful hit deals 1d6+1 points of damage as the harpoon hooks the flesh of the target and immediately exudes a thick, sticky glue. The spider can reel in a harpoon as a free action; treat this as a trip attack (+21 bonus) against any creature attached to the fang. Failure indicates that the harpoon rips free (and deals another 1d4+1 points of damage to the victim). Success indicates that the victim is pulled off its feet and dragged back to the spider, who can immediately make a free bite attack against the victim. A harpoon spider can only pull a creature smaller than itself in this manner. Attempts to retract a creature of its own size or larger automatically cause the fang to rip free as if the trip attack failed. The glue exuded by the spider's fangs decomposes quickly, and at the end of the spider's turn the fang automatically detaches.

Poison (Ex) Injury, Fortitude DC 20, initial damage 1d6 Dex, secondary damage 2d6 Dex. The save DC is constitution based.

Spines (Ex) Any creature striking a harpoon spider with its body or a handheld weapon, must make a DC 17 Reflex save or take 1d8 points of piercing damage from the spider's spines. (Creatures wielding reach weapons, such as long spears, are not subject to this damage.) The spines also deal an extra 1d6 points of

damage on a successful grapple check (much like armor spikes). The save DC is Dexterity-based. As a full-round action, a harpoon spider can pick up a Medium or smaller helpless creature with its legs and impale the body on its spines, dealing 3d6 points of piercing damage. The spider can carry up to 2 Medium, 8 Small, 32 Tiny, or 128 Diminutive or smaller creatures in this manner. Harpoon spiders often use this method to carry their next meals.

Web Movement (Ex) Although they cannot spin webs themselves, harpoon spiders can climb around and through webs with ease using their climb speed.

They are immune to the effects of the *web* spell

Skills A harpoon spider has a +8 racial bonus on Climb checks and Jump checks, and it can always choose to take 10 on a Climb check, even if rushed or threatened.

3B: KICKING UP A STINK**ADVANCED FETID FUNGUS* CR 3****Monster Manual V 56*

N Large plant

Init +2; **Senses** blind, blindsight 60 ft.; Listen +0**Aura** sickening gas (DC 16, 30 ft.)**Languages** —**AC** 13, touch 7, flat-footed 15

(-1 size, -2 Dex, +6 natural)

hp 40 (6 HD); death throes**Immune** acid, gaze attacks, illusions, plant immunities, visual effects**Fort** +6, **Ref** +0, **Will** +2**Weakness** vulnerability to fire**Speed** 20 ft. (4 squares)**Melee** acid touch +8 (1d6+5 acid)**Space** 10 ft.; **Reach** 5 ft.**Base Atk** +4; **Grp** +13**Atk Options** decomposing slime, engulf**Abilities** Str 20, Dex 6, Con 17, Int 1, Wis 10, Cha 5**SQ** plant traits**Feats** Ability Focus (engulf), Improved Initiative, Track**Skills** Hide -1 (+9 in swampy terrain), Listen +0, Survival +4

Sickening Gas (Ex) A fetid fungus's amorphous body is filled with gases given off by decomposing matter. All living creatures within 30 feet of a fetid fungus must succeed on a DC 12 Fortitude save or be sickened for 10 rounds. The save DC is Constitution-based.

Death Throes (Ex) When destroyed, a fetid fungus explodes in a 10-foot-radius burst of corrosive ichor that deals 1d4 points of acid damage (Reflex DC 12 half) to all creatures in the area. The save DC is Constitution-based.

Decomposing Slime (Ex) A fetid fungus's body produces a decomposing slime. Any creature that strikes or touches a fetid fungus with its body, or that grapples a fetid fungus, takes 1 point of acid damage. A creature takes damage from this ability only once per round.

Engulf (Ex) As a standard action, a fetid fungus can envelop creatures of its size or smaller, entrapping them within itself. The fungus simply moves into the opponent's space; any creature whose space it completely covers is subject to the engulf attack. A fungus cannot make a touch attack during a round in which it engulfs. It can engulf as many creatures as can fit in its space.

Opponents can make attacks of opportunity against the fungus, but, if they do so, they are not entitled to a saving throw. Those who do not attempt attacks of opportunity must succeed on a DC 14 Reflex save or be engulfed. On a success, a creature moves aside or back (opponent's choice) to move out of the fungus's path. The save DC is Constitution-based. Engulfed creatures are considered to be grappled within the fungus's body, they are subject to its touch

attack, and they take 1 point of acid damage per round from its decomposing slime.

Skills Fetid fungi have a +10 racial bonus on Hide checks when in marsh or swamp terrain.

3D: HOME OF THE SWARM**DREAD BLOSSOM SWARM* CR 6****Monster Manual III 45*

N Tiny plant (extraplanar, swarm)

Init +3; **Senses** low-light vision, Listen +2, Spot +2**Languages** —**AC** 16, touch 15, flat-footed 13

(+2 size, +3 Dex, +1 natural)

hp 45 (7 HD); **regeneration** 5; half damage from slashing and piercing weapons**Immune** critical hits, sneak attacks and flanking, spells that target a specific number of creatures; mind affecting spells and effects, poison, sleep effects, polymorph, paralysis, stunning**Fort** +7, **Ref** +10, **Will** +2**Weakness** area attacks**Speed** fly (good) (12 squares)**Melee** swarm (2d6 plus blood drain and distraction)**Space** 10 ft.; **Reach** 0 ft.**Base Atk** +5; **Grp** —**Atk Options** blood drain, distraction, poison pollen**Abilities** Str 2, Dex 17, Con 14, Int —, Wis 10, Cha 3**Feats** Alertness^B, Ability Focus (poison pollen)^B, Lightning Reflexes^B**Skills** Hide +4 (+14 in forested areas), Listen +2, Spot +2

Regeneration (Ex) Fire and cold deal normal damage to a dread blossom swarm.

Blood Drain (Ex) In addition to swarm damage, a dread blossom swarm deals 1d6 points of Constitution damage to any paralyzed or otherwise immobilized living creature whose space it occupies at the end of its turn.

Distraction (Ex) Any living creature vulnerable to a dread blossom swarm's damage that begins its turn with a swarm in its square, is nauseated for 1 round; a DC 15 Fortitude save negates the effect. Even after a successful save, spellcasting or concentrating of spells within the area of a swarm, requires a Concentration check (DC 20 + spell level). Using skills requiring patience and concentration requires a DC 20 Concentration check. The save DC is Constitution-based.

Poison Pollen (Ex) A dread blossom swarm constantly exudes an airborne contact poison in a 15-foot radius. Creatures within the area or within the swarm must succeed on a DC 17 Fortitude save or be paralyzed for 1 round. Secondary damage is paralysis for 1 minute. The save DC is Constitution-based.

Skills A dread blossom swarm gains a +10 racial bonus on Hide checks in forested areas.

3I: HOME SWEET HOME

ADVANCED HARPOON SPIDER* CR 6

**Monster Manual III* 80

CE Huge aberration

Init +4; **Senses** darkvision 120 ft., Listen +1, Spot +9

Languages Common, Sylvan

AC 17, touch 11, flat-footed 14; spines

(-2 size, +3 Dex, +6 natural)

hp 135 (13 HD)

Resist evasion

Immune vermin immunities, *web*

Fort +9, **Ref** +7, **Will** +7

Speed 40 ft. (8 squares), climb 20 ft.; web movement

Melee bite +19 (2d6+8 plus poison)

Ranged 2 fangs +15 each (1d6+1 plus harpooning)

Space 10 ft.; **Reach** 5 ft.

Base Atk +13; **Grp** +29

Atk Options Combat Reflexes, Improved Bull Rush, Improved Trip, Power Attack harpooning, poison,

Abilities Str 26, Dex 18, Con 22, Int 14, Wis 12, Cha 9

Feats Ability Focus (poison), Combat Reflexes, Improved Bullrush, Improved Toughness, Improved Trip^B, Power Attack

Skills Balance +9, Climb +31, Hide +12, Jump +33, Spot +9, Tumble +11

Harpooning (Ex) As ranged attacks, a dreadharpoon spider can fire one or two of its fangs up to 20 feet (no range increment). The spider can fire at two different targets if it chooses. A successful hit deals 1d6+1 points of damage as the harpoon hooks the flesh of the target and immediately exudes a thick, sticky glue. The spider can reel in a harpoon as a free action; treat this as a trip attack (+21 bonus) against any creature attached to the fang. Failure indicates that the harpoon rips free (and deals

another 1d4+1 points of damage to the victim).

Success indicates that the victim is pulled off its feet and dragged back to the spider, who can immediately make a free bite attack against the victim. A harpoon spider can only pull a creature smaller than itself in this manner. Attempts to retract a creature of its own size or larger automatically cause the fang to rip free as if the trip attack failed. The glue exuded by the spider's fangs decomposes quickly, and at the end of the spider's turn the fang automatically detaches.

Poison (Ex) Injury, Fortitude DC 24, initial damage 1d6 Dex, secondary damage 2d6 Dex. The save DC is constitution based.

Spines (Ex) Any creature striking a harpoon spider with its body or a handheld weapon, must make a DC 17 Reflex save or take 1d8 points of piercing damage from the spider's spines. (Creatures wielding reach weapons, such as long spears, are not subject to this damage.) The spines also deal an extra 1d6 points of damage on a successful grapple check (much like armor spikes). The save DC is Dexterity-based.

As a full-round action, a harpoon spider can pick up a Medium or smaller helpless creature with its legs and impale the body on its spines, dealing 3d6 points of piercing damage. The spider can carry up to 2 Medium, 8 Small, 32 Tiny, or 128 Diminutive or smaller creatures in this manner. Harpoon spiders often use this method to carry their next meals.

Web Movement (Ex) Although they cannot spin webs themselves, harpoon spiders can climb around and through webs with ease using their climb speed.

They are immune to the effects of the *web* spell

Skills A harpoon spider has a +8 racial bonus on Climb checks and Jump checks, and it can always choose to take 10 on a Climb check, even if rushed or threatened.

3B: KICKING UP A STINK**ADVANCED FETID FUNGUS* CR 3****Monster Manual V 56*

N Large plant

Init +2; **Senses** blind, blindsight 60 ft.; Listen +0**Aura** sickening gas (DC 16, 30 ft.)**Languages** —**AC** 13, touch 7, flat-footed 15
(-1 size, -2 Dex, +6 natural)**hp** 40 (6 HD); death throes**Immune** acid, gaze attacks, illusions, plant immunities, visual effects**Fort** +6, **Ref** +0, **Will** +2**Weakness** vulnerability to fire**Speed** 20 ft. (4 squares)**Melee** acid touch +8 (1d6+5 acid)**Space** 10 ft.; **Reach** 5 ft.**Base Atk** +4; **Grp** +13**Atk Options** decomposing slime, engulf**Abilities** Str 20, Dex 6, Con 17, Int 1, Wis 10, Cha 5**SQ** plant traits**Feats** Ability Focus (engulf), Improved Initiative, Track**Skills** Hide -1 (+9 in swampy terrain), Listen +0, Survival +4

Sickening Gas (Ex) A fetid fungus's amorphous body is filled with gases given off by decomposing matter. All living creatures within 30 feet of a fetid fungus must succeed on a DC 12 Fortitude save or be sickened for 10 rounds. The save DC is Constitution-based.

Death Throes (Ex) When destroyed, a fetid fungus explodes in a 10-foot-radius burst of corrosive ichor that deals 1d4 points of acid damage (Reflex DC 12 half) to all creatures in the area. The save DC is Constitution-based.

Decomposing Slime (Ex) A fetid fungus's body produces a decomposing slime. Any creature that strikes or touches a fetid fungus with its body, or that grapples a fetid fungus, takes 1 point of acid damage. A creature takes damage from this ability only once per round.

Engulf (Ex) As a standard action, a fetid fungus can envelop creatures of its size or smaller, entrapping them within itself. The fungus simply moves into the opponent's space; any creature whose space it completely covers is subject to the engulf attack. A fungus cannot make a touch attack during a round in which it engulfs. It can engulf as many creatures as can fit in its space.

Opponents can make attacks of opportunity against the fungus, but, if they do so, they are not entitled to a saving throw. Those who do not attempt attacks of opportunity must succeed on a DC 14 Reflex save or be engulfed. On a success, a creature moves aside or back (opponent's choice) to move out of the fungus's path. The save DC is Constitution-based. Engulfed creatures are considered to be grappled within the fungus's body, they are subject to its touch attack, and they take 1 point of acid damage per round from its decomposing slime.

Skills Fetid fungi have a +10 racial bonus on Hide checks when in marsh or swamp terrain.

3D: HOME OF THE SWARM**DREAD BLOSSOM SWARM* CR 6****Monster Manual III 45*

N Tiny plant (extraplanar, swarm)

Init +3; **Senses** low-light vision, Listen +2, Spot +2**Languages** —**AC** 16, touch 15, flat-footed 13
(+2 size, +3 Dex, +1 natural)**hp** 45 (7 HD); **regeneration** 5; half damage from slashing and piercing weapons**Immune** critical hits, sneak attacks and flanking, spells that target a specific number of creatures; mind affecting spells and effects, poison, sleep effects, polymorph, paralysis, stunning**Fort** +7, **Ref** +10, **Will** +2**Weakness** area attacks**Speed** fly (good) (12 squares)**Melee** swarm (2d6 plus blood drain and distraction)**Space** 10 ft.; **Reach** 0 ft.**Base Atk** +5; **Grp** —**Atk Options** blood drain, distraction, poison pollen**Abilities** Str 2, Dex 17, Con 14, Int —, Wis 10, Cha 3**Feats** Alertness^B, Ability Focus (poison pollen)^B, Lightning Reflexes^B**Skills** Hide +4 (+14 in forested areas), Listen +2, Spot +2

Regeneration (Ex) Fire and cold deal normal damage to a dread blossom swarm.

Blood Drain (Ex) In addition to swarm damage, a dread blossom swarm deals 1d6 points of Constitution damage to any paralyzed or otherwise immobilized living creature whose space it occupies at the end of its turn.

Distraction (Ex) Any living creature vulnerable to a dread blossom swarm's damage that begins its turn with a swarm in its square, is nauseated for 1 round; a DC 15 Fortitude save negates the effect. Even after a successful save, spellcasting or concentrating of spells within the area of a swarm, requires a Concentration check (DC 20 + spell level). Using skills requiring patience and concentration requires a DC 20 Concentration check. The save DC is Constitution-based.

Poison Pollen (Ex) A dread blossom swarm constantly exudes an airborne contact poison in a 15-foot radius. Creatures within the area or within the swarm must succeed on a DC 17 Fortitude save or be paralyzed for 1 round. Secondary damage is paralysis for 1 minute. The save DC is Constitution-based.

Skills A dread blossom swarm gains a +10 racial bonus on Hide checks in forested areas.

3I: HOME SWEET HOME

ADVANCED DREAD HARPOON SPIDER* CR 10

**Monster Manual III* 45

CE Huge aberration

Init +3; **Senses** darkvision 120 ft., Listen +1, Spot +10

Languages Common, Sylvan

AC 19, touch 11, flat-footed 16; spines
(-2 size, +3 Dex, +8 natural)

hp 138 (13 HD)

Resist evasion

Immune vermin immunities, *web*

Fort +9, **Ref** +8, **Will** +7

Speed 40 ft. (8 squares), climb 20 ft.; web movement

Melee bite +14 (2d6+7 plus poison)

Ranged 2 fangs +10 each (1d6+3 plus harpooning)

Space 15 ft.; **Reach** 10 ft.

Base Atk +9; **Grp** +16

Atk Options Combat Reflexes, Power Attack, Improved Bull Rush, Improved Trip, Point Blank Shot, harpooning, poison,

Abilities Str 25, Dex 17, Con 23, Int 14, Wis 12, Cha 9

Feats Ability Focus (poison), Combat Reflexes, Improved Toughness, Improved Trip^B, Lightning Reflexes, Point Blank Shot

Skills Balance +11, Climb +27, Hide +17, Jump +27, Spot +10, Tumble +16

Harpooning (Ex) As ranged attacks, a dreadharpoon spider can fire one or two of its fangs up to 20 feet (no range increment). The spider can fire at two different targets if it chooses. A successful hit deals 1d6+1 points of damage as the harpoon hooks the flesh of the target and immediately exudes a thick, sticky glue. The spider can reel in a harpoon as a free action; treat this as a trip attack (+21 bonus) against any creature attached to the fang. Failure

indicates that the harpoon rips free (and deals another 1d4+1 points of damage to the victim). Success indicates that the victim is pulled off its feet and dragged back to the spider, who can immediately make a free bite attack against the victim. A harpoon spider can only pull a creature smaller than itself in this manner. Attempts to retract a creature of its own size or larger automatically cause the fang to rip free as if the trip attack failed. The glue exuded by the spider's fangs decomposes quickly, and at the end of the spider's turn the fang automatically detaches.

Poison (Ex) Injury, Fortitude DC 24, initial damage 1d6 Dex, secondary damage 2d6 Dex. The save DC is constitution based.

Spines (Ex) Any creature striking a harpoon spider with its body or a handheld weapon, must make a DC 17 Reflex save or take 1d8 points of piercing damage from the spider's spines. (Creatures wielding reach weapons, such as long spears, are not subject to this damage.) The spines also deal an extra 1d6 points of damage on a successful grapple check (much like armor spikes). The save DC is Dexterity-based.

As a full-round action, a harpoon spider can pick up a Medium or smaller helpless creature with its legs and impale the body on its spines, dealing 3d6 points of piercing damage. The spider can carry up to 2 Medium, 8 Small, 32 Tiny, or 128 Diminutive or smaller creatures in this manner. Harpoon spiders often use this method to carry their next meals.

Web Movement (Ex) Although they cannot spin webs themselves, harpoon spiders can climb around and through webs with ease using their climb speed.

They are immune to the effects of the *web* spell

Skills A harpoon spider has a +8 racial bonus on Climb checks and Jump checks, and it can always choose to take 10 on a Climb check, even if rushed or threatened.

DM MAP 1: ZONE LAYOUT

OVERVIEW OF THE MAZE

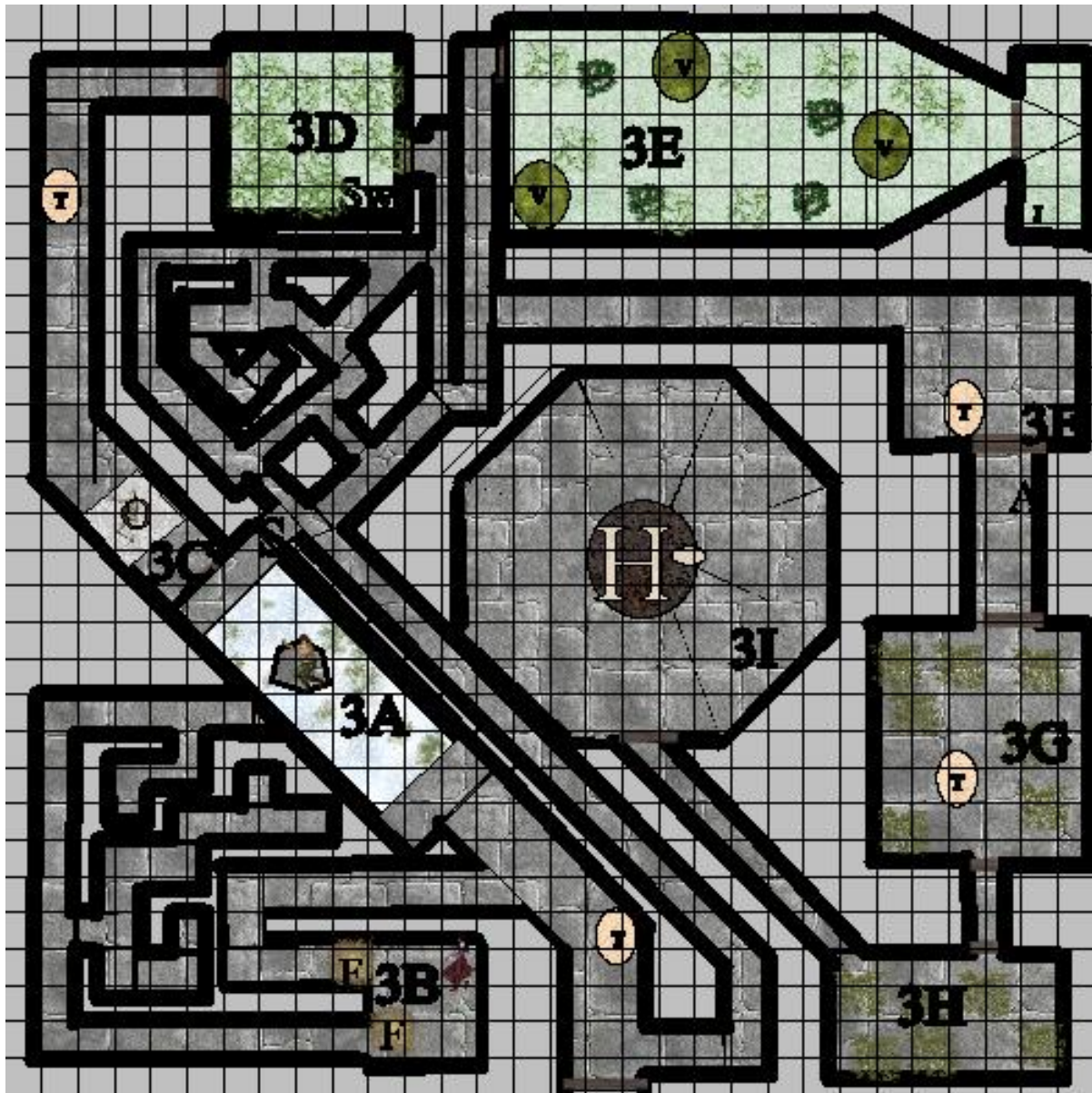

AFFILIATION BRIEFING SHEETS

GUILD OF WIZARDRY

As you know, we're holding an exhibition of the treasures from Castle Greyhawk's ruins. Of course, this had to come in AFTER we'd opened the display so we couldn't do anything about it, but we've divined a small problem. Seems there's a threat – negligible, negligible, or we'd have closed the display right away. Anyway, one of the objects poses a small threat to some, also unidentified citizens of the City (no, I don't know who!) and we'd like you to take a walk through the exhibition and see if you can find out which one. Don't go casting any spells, just walk through and see what you notice. Anything that needs more attention, can be magicked *after hours*, okay?

MERCHANTS' AND TRADERS' UNION

Now, this is serious. There's no way the wizards would have gotten all that stuff from just adventurers. Rumor has it that more than a few shops are doing a roaring trade in antiquities and we don't believe that all of the finds have been declared. We want you to go and take a note of each item, and who is listed as its source. Bring it all back here, and we'll check our records. Chances are there's some who've been dodging guild taxes. If we find them from your lists, you'll be well rewarded.

MERCENARIES' GUILD

As you know, the Guild of Wizardry has insisted on holding this exhibit of the treasures from Castle Greyhawk's ruins. What you might not know is that they've asked us to be security for them. Now, it would have been better if they'd let us go over the layout of the display before they opened to the public, and if they'd let us identify some of the more questionable objects, but they didn't. We've already provided guards, but what we'd like you to do, is take a look at the exhibit from a punter's point of view. Make a note of anything you think could constitute a weak spot in security, and let us know. Take your time – we'd like your report by this afternoon.

CARTOGRAPHERS' GUILD

It's really good of the wizards to put on this display and all, but I wonder that they didn't let us look at it long ago. So, go take a long hard look at what's on display. The ancients used to hide maps in all sorts of designs, and the wizards might have missed the significance – after all, it's not their field, so just go and take a close look at what's on display and see if there isn't a map or two hiding amongst it all.

THIEVES' GUILD

Look, it's just a little reconnaissance, okay? Just take a gander at what's on display, check out the guards, look for protective spells if you're able, and come back and tell us what you think. Look at what's easy to get to, what's easy to carry, and what might be worth earning the ire of an upset wizard or three. For all we know, it's nothing but junk and not worth the effort, but you never know... And don't touch nuffink!

NIGHTWATCHMEN

Wizards! Idiots all! Putting that much treasure on display is only asking for trouble. The Mercenaries Guild has the contract for security, but we'd like you to give the place a once over. See if you can spot any weaknesses in security, and keep an eye out for the usual suspects; if they're there, then they're planning something.

RELIGIOUS ORGANIZATIONS

Look, I know it's not really our jurisdiction, and I'm sure the Mercenaries Guild and the wizards know what they're doing, but there's something seriously wrong with an item in that new display the Academy has opened. Now, the divination didn't go into specifics, but there's the small chance of something harming the city. When we tried to push it, the only response indicated sickness, disease, and things not being what they seemed. Hardly helpful. Anyway, can you just pop over and see if there's an item that might prove promising for further investigation? Don't touch anything, or cast any spells – the wizards are touchy enough. Just observe and see if there's something that looks like it might be what we're after.

The Tomb of Pelor

by R. Michael Hinds

ADVENTURE BACKGROUND

A previously unknown cavern buried deep beneath the War Tower has great interest among the Pelorites of the free city. Given the depth of the discovered cavern, anything entombed therein may be several thousands of years old.

Access to the cavern was made possible by an earthquake – likely the same quake which devastated Levels 4 and 5 (Shatterstone), creating a jagged rift from the Level 4 of the War Tower to the cavern.

Initial forays into the cavern have pronounced it “spooky”, “disturbing”, and “deadly”. At least one scholar has pronounced the very existence of the cavern to be absurd.

From the rift exit, the disturbing nature of the cavern is readily apparent – a low level of illumination pervades the area. This illumination is from the dying power infused by Pelor into this once great Flan temple. The source of the illumination is the statue. The statue is also responsible for the disturbing and spooky adjectives ascribed to the cavern. Only one scout returned with a brief description of a temple beyond the statue and he spoke of a horrible presence emanating from within.

The temple is indeed an ancient Flan temple dedicated to Pelor and completely adheres to the tenets of what is now termed “The Old Faith”. A follower of Incabulos, however, is corrupting the temple. The Incabulite, Herceptus the Undying, was sent to Castle Greyhawk years ago by his superior, Envira Mistress of Pox.

Originally housing itself in the Crypts of the Forgotten, Herceptus moved his demesne to this temple to escape predations by the forces of Iuz. Herceptus profaned the temple in the name of Incabulos. Herceptus has used this place to develop horror after horror, using the surrounding Cairn Hills and Greyhawk environs as testing grounds.

Recently, High Matriarch Sarana learn of the temple and has begun to seeking brave adventurers to investigate.

ADVENTURE SUMMARY

The PCs are asked by High Matriarch Sarana to explore an area deep beneath the War Tower. She asks that they

explore the cavern temple and determine, from markings and any other artifacts left behind, if the temple was dedicated to Pelor. She would also like to see the area cleansed of the rumored “horrible presence” if that is possible.

Scholars believe if the temple is dedicated specifically to Pelor then this may be relic of a once great ancient Flan civilization. It may even be an indication that the Empire of Sulm may have reached outside the present day boundaries of the Bright Desert. Alternatively, it might be the first sign of another lost Flan kingdom.

PREPARATION FOR PLAY

The following spells and effects do not operate in or near the ancient Flan temple:

No divination school spells work within 500 yards of the temple environs. This includes but is not limited to: *arcane eye*, *arcane sight*, *augury*, *clairaudience/clairvoyance*, *commune*, *comprehend languages*, *contact other plane*, *detect* (all), *discern lies*, *discern location*, *divination*, *find the path*, *find traps*, *foresight*, *legend lore*, *locate* (all), *moment of prescience*, *prying eyes*, *read magic*, *screying*, *see invisibility*, *status*, *Rary's lesser telepathic bond*, *Rary's telepathic bond*, *tongues*, *true seeing*, and *true strike*.

These spells simply fail immediately upon being cast, with no indication as to the cause. This includes any spell-like or supernatural abilities that produce similar effects, such as a paladin's ability to *detect evil*. Any PC who makes a Knowledge (arcana) or Spellcraft check DC 20 after casting any divination spell can determine that area is simply “absorbing” the magic, and that further attempts at divination spells would prove fruitless. This effect does not apply to the Statue of Pelor – the spell turret trap acts as normal.

INTRODUCTION

There are no affiliation briefing sheets for this adventure zone. All the PCs have a common purpose and employer. Read:

One does not lightly ignore a summons from High Matriarch Sarana - Pelor's representative in the free

city – and so you found yourself in the Garden Quarter at the Pelor’s rather rundown temple.

High Matriarch Sarana herself met you and asked you to undertake a task of great import for her. She asked you explore a newly discovered cavern somewhere between the Crypts of the Forgotten and the Shatterstone that may contain the ruins of a long-lost (and probably ancient) temple of Pelor. Apparently, the building may be under some kind of insidious, malign influence and she wants it investigated and purified. In return, she promises reward and enhanced standing with her faith.

Allow the PCs to make any preparations they deem necessary given the information they have learned from Matriarch Sarana before they set out for the ruins. If they think to ask for some way to purify the temple, she gives them a scroll of consecrate. Use the information presented here and in the Adventure Background to answer any other questions the PCs may ask.

Use Encounter One in the main part of this adventure if they try to learn more about Castle Greyhawk. Run Encounters Two when the PCs leave the city.

When the PCs reach the War Tower, read:

Many beings are lined up before an ancient gatehouse, grouped into adventuring parties, to brave the possible dangers of the castle.

All the explorers are asked to assemble before a small grand stand erected on the leeward side of the dwarven guild house. A bulky dwarf, his beard streaked with a mixture of red and grey, mounts the stand and addresses the gathered group.

“You few, you lucky few, have been selected for the exploration of the War Tower! Glory and loot no doubt await you within its depths. The glory you can have all to yourselves but a portion of the plunder belongs to us!”

As the other adventurers march into the tower, Stillguar turns to the PCs:

“Matriarch Sarana has apprised me of your task. A scout will lead you to the recently discovered rift that leads to a cavern positioned somewhere between the Crypts of the Forgotten and the Shatterstone.

“At the end of the rift is a large intact structure, possibly an ancient temple. If you have any questions, they’re best left unasked as I haven’t any answers! You’re the adventurers!”

A DC 20 Knowledge (Core) check, identifies the dwarf as Stillguar (LN male dwarf cleric 9/fighter 6), leader of the Wartower Wardens. PCs who have been here before know this automatically.

Use the information presented in Encounter 3 of the main adventure to handle any conversation the PCs have with Stillguar.

1: THE STATUE OF PELOR

The travel into the depths of the War Tower is without incident but the way was slow going.

You finally reach a large crack in the bottom and side of a disused chamber. The scout points into the hole and says it leads to the rift. The rift is steep, narrow and about 200 yards long.

Exiting the rift, you enter a large cavern, the entire scope of which is difficult to discern but the strangeness is readily apparent – a dim radiance suffuses the entire cavern. At the far end, opposite the rift, is a large intact stone edifice. The floor of the cavern is partially paved in large granite flagstones. At the center of this paved area is a twenty-foot-tall statue. From the rift exit the statue’s features are difficult to discern.

Have the players place their figures at the far end of the cavern, facing the temple. The cavern is 90-feet-wide by 100-feet-long, with a ceiling height of 50 feet. The statue is halfway between the temple entrance and the rift exit.

The statue is of an antiquated depiction of Pelor. The original features of the statue were crude although the figure is humanoid in shape. The head is round and surrounded by a many pointed solar disc. Treat the statue as Huge. A DC 15 Knowledge (religion) check, or a DC 20 Knowledge (history) check, identifies the statue as being a representation of the Flan deity Pelor. PCs succeeding on a DC 12 Spot check notice the eyes of the statue are made of gold and the tips of the solar disc are embedded with diamonds.

Trap: The statue has an integrated trap, part of the temple’s ancient defenses. Located in the head of the 20-foot tall statue is a deadly spell turret trap. When inactive, the spell turret is cloaked by a *nondetection* spell (Caster Level 20th) to hide its magical auras. The spell turret is programmed to recognize Flan bearing any of a series of facial tattoos. Any Flan PC who is tattooed in the traditional manner has a 25% chance of bearing a tattoo which marks them as safe to the spell turret.

Tattoo Note: Any PC who has any of the following AR items from COR5-09 *Gateway to Bright Sands* is automatically recognized by the statue and not attacked: Sulm Tattoo, Magical Tattoo, or Spirit Tattoo.

Trap Activation: The spell turret has a visual trigger that utilizes *true seeing* to a range of 50 feet. If the turret detects an unrecognized target, it immediately activates. When it does, the solar disc surrounding the statue’s head emits a flash of colorful light. The turret is the solar disc and is free to spin, utilizing a groove in the neck. Four of the points on the solar disc contain enchanted gemstones which release the various programmed spells. The spell turret unleashes one spell per round for four rounds, pausing every fifth round to cool down and magically repair 4d8+20 points of damage to itself. The turret targets the closest unrecognized creature and has a 360 degree

arc of fire. The order in which the turret casts its spells is set. All spells have a range of 50 feet.

APL 2 (EL 1)

☞ **Spell Turret Trap:** CR 1; diminutive magical device; visual trigger (*true seeing*); automatic reset; *acid splash, daze, ray of frost, touch of fatigue* (as a ray); Save DC 10, Caster Level 1st; AC 7, hardness 8; hp 200; Search DC 25; Disable Device DC 25.

APL 4 (EL 2)

☞ **Spell Turret Trap:** CR 2; diminutive magical device; visual trigger (*true seeing*); automatic reset; *grease, sleep, magic missile, ray of enfeeblement*; Save DC 12, Caster Level 1st; AC 7, hardness 8; hp 200; Search DC 26; Disable Device DC 26.

APL 6 (EL 3)

☞ **Spell Turret Trap:** CR 3; diminutive magical device; visual trigger (*true seeing*); automatic reset; *web, daze monster, scorching ray, blindness*; Save DC 13, Caster Level 3rd; AC 7, hardness 8; hp 200; Search DC 27; Disable Device DC 27.

APL 8 (EL 4)

☞ **Spell Turret Trap:** CR 4; diminutive magical device; visual trigger (*true seeing*); automatic reset; *stinking cloud, deep slumber, fireball, ray of exhaustion*; Save DC 14, Caster Level 5th; AC 7, hardness 8; hp 200; Search DC 28; Disable Device DC 28.

Creatures: Minions of Iuz hide in wait 60 feet away in an area containing rubble west of the statue. Their hope is the PCs disable the trap within the statue. Balance this desire with their unwillingness to allow the PCs to enter the temple and potentially gain some advantage. Should the PCs enter the rubble to seek cover from the spell turret trap, the Minions of Iuz attack. Allow PCs Spot checks versus the Minions' Hide, modified by distance. Otherwise, have them attack at an opportune moment. It possible they stay out of range of the spell turret.

APL 2 (EL 4)

☞ **Dretch (2):** hp 13 each; MM 42.

APL 4 (EL 6)

☞ **Dretch (2):** hp 13 each; MM 42.

☞ **Acolyte of Iuz:** hp 29; Appendix 1.

APL 6 (EL 8)

☞ **Babau:** hp 66; MM 40.

☞ **Acolyte of Iuz:** hp 29; Appendix 1.

APL 8 (EL 10)

☞ **Babau:** hp 66; MM 40.

☞ **Servitor of Iuz:** hp 67; Appendix 1.

Tactics: The Minions of Iuz begin with cover in the rubble field. The dretches make use of their *stinking cloud* and *scare* spell-like abilities to incapacitate and separate the party then concentrate on lone individuals. One dretch, in the first round of combat, attempts to summon additional tanar'ri. If an Acolyte is present, the evil cleric tries to further incapacitate a PC with *doom* or his *scroll of sound burst*. The Acolyte, if unmolested, may cast *invisibility* and use this to gain position on the PCs. Thereafter, the Acolyte enters melee combat with whoever looks the weakest. The babau uses *stealth, darkness*, and its teleportation spell-like ability to arrange position for sneak attack.

The Servitor acts much in the same way as an Acolyte but also casts *invisibility* upon the babau as soon as possible. The Servitor, if uninjured, may heal the babau.

Remember if the statue's spell turret trap has not been disabled or destroyed, it targets creatures within 50 feet. Roll randomly to determine the target is there is more than one.

Treasure: Refer to the Treasure Summary to determine what the PCs find here.

Development: This encounter may be successfully completed by 1) bypassing the trap either due to Flan heritage or clever thinking; 2) running into the temple to avoid the continued spell flinging by the trap; or 3) destroying the trap. In any of these three cases, the Minions of Iuz must be defeated or driven away.

The entrance to the temple has no door – it has long since rotted away. PCs can flee into the temple to avoid the spell turret trap. The turret is programmed to not fire spells into the temple.

2: ANCIENT TEMPLE OF PELOR

The interior of the temple would be glorious, if not for the obvious profane desecration it has undergone. Evil runes have been carved onto once holy surfaces. The floor is littered with bones and other detritus.

At the center of the sanctuary is a raised dais. In the dais' center, piercing a magnificent mosaic of Pelor's visage, is a blackened iron stand holding a pulsating black stone. Standing next to this is a humanoid skeleton, still wearing the tatters of some ceremonial robe and a blackened disc on a chain about its neck. The creature's bones sparkle in dim light spilling down from an opening above the dais.

The creature raises both arms and clacks its jaws loudly – the clacking is echoed from alcoves on either side!

The blackened iron stand on the dais has a receptacle on top holding a large black onyx. The onyx radiates the power of a *desecrate* spell. All Charisma checks made to

turn undead suffer a -3 profane penalty and every undead creature entering the desecrated area (20-foot-radius emanation) gains a +1 profane bonus on attack rolls, damage rolls, and saving throws. An undead creature created within or summoned into the area gains +1 hit points per hit die. (See page 218 of the *Player's Handbook* for additional detail.)

◆ **Blackened Iron Stand:** 1.5 in. thick; hardness 10; hp 25; AC 5; Break DC 24.

◆ **Desecration Onyx:** hardness 5; hp 15; AC 9; Break DC 20.

APL 2 (EL 3)

◆ **Human Warrior Skeletons (6):** hp 7 each; Appendix 1.

◆ **Revived Fossil Human Cleric (1):** hp 27; Appendix 1.

APL 4 (EL 5)

◆ **Human Warrior Skeletons (6):** hp 7 each; Appendix 1.

◆ **Revived Fossil Human Cleric (1):** hp 27; Appendix 1.

◆ **Plague Walker (1):** hp 48; Appendix 1.

APL 6 (EL 7)

◆ **Bone Creature Warrior (6):** hp 21 each; Appendix 3.

◆ **Revived Fossil Human Cleric (4):** hp 27; Appendix 3.

◆ **Plague Walker (1):** hp 48; Appendix 3.

APL 8 (EL 9)

◆ **Bone Creature Warrior (6):** hp 37 each; Appendix 1.

◆ **Revived Fossil Human Cleric (5):** hp 27; Appendix 1.

◆ **Plague Walker (4):** hp 48; Appendix 1.

Tactics: The undead attack until destroyed, except for the plague walker. When the plague walker is reduced to sufficient hit points to use its putrid burst ability, it wades into the area containing the most living creatures and explodes.

Destroying the onyx stone ends the desecration aura, but does not restore the sanctity of the altar of Pelor.

DEVELOPMENT

In the rear of the temple are stairs down to the catacombs. This area was once partitioned off from the sanctuary by doors. The stone hinges are still visible.

If the *desecration onyx* is destroyed, the profane aura is eliminated. The altar of Pelor, however, is still desecrated. A *consecrate* spell, cast by a cleric of Pelor or by a cleric of any Old Faith deity (Alitur, Beory, Ehlonna, Obad-Hai, Nerull) immediately restores the altar and triggers the hidden opening once leading to the deep catacombs. A

cleric of a good deity may also cast *consecrate* upon the altar but may suffer penalties for doing so, depending upon the deity (Pholtus, for example, would not think highly of consecrating an altar to Pelor). The suggested penalty is a -1 circumstance penalty to all skill and ability checks for 1 hour. In this second case or if no *consecrate* is attempted, the hidden opening must be found with a Search check, DC 20+APL.

Once found, the hatch may be opened by pressing a few tiles of the mosaic. In either case, the opening reveals a staircase and the light coming from above intensifies. Those who investigate find the staircase choked with rubble about 10 feet down. A Search check, DC 10, allows PCs to find an alcove containing some ancient Pelorite treasure.

PCs who consecrate the altar of Pelor receive the Cleansing of the Sun AR reward in addition to a story XP reward.

Treasure: This treasure is located within an alcove on a wall adjoining the hidden stairway below the altar dais. The potions are clearly labeled in Flan. Refer to the Treasure Summary to determine what the PCs find here.

Troubleshooting: If the PCs fail to find the secret door either by failing the Search check or by not casting *consecrate*, they can return to the surface. When they report to High Matriarch Sarana she provides them with a scroll of *consecrate* and asks them to cast it in the temple to wipe away the terrible desecrations visited upon the temple.

3: THE CRYPT

A horrid, foul stench drives upward from the staircases.

Below, this once magnificent crypt is so befouled, one wonders if even the purifying light of Pelor could make this place holy once more. The initial impression is that the space is being used as some sort of necromantic laboratory.

Portions of the floor seem to move and shift. As your eyes adjust to this phenomenon, you realize it is not the floor, but mats of black hair attached to gray, greasy pieces of scalp.

At the far end of the crypt, beyond the horrific detritus of the necromantic laboratory, is a large sarcophagus set into the stone floor.

You hear squelchy scuttling on the ceiling. Looking up, you see a horrid amalgam of rotting flesh bound to twisted limbs, climbing on all four of its awkward appendages amongst a swath of corpses plastered on the ceiling. Great bands of black iron seem to hold the various pieces of the creature's putrid tissue together. The thing drops to the floor and you can feel its malign influence as it closes to attack!

APL 2 (EL 6)

◆ **Necrosis Carnex (1):** hp 26; Appendix 1.

◆ **Herceptus the Undying:** hp 12; Appendix 1.

APL 4 (EL 8)

- **Necrosis Carnex (2):** hp 26; Appendix 1.
- **Herceptus the Undying:** hp 26; Appendix 1.

APL 6 (EL 10)

- **Advanced (8 HD) Necrosis Carnex (2):** hp 52; Appendix 1.
- **Herceptus the Undying:** hp 40; Appendix 1.

APL 8 (EL 12)

- **Advanced (8 HD) Necrosis Carnex (4):** hp 52; Appendix 1.
- **Herceptus the Undying:** hp 54; Appendix 1.

Tactics: Depending upon the noise made upstairs during the previous combat, Herceptus begins this combat with *resist energy (fire)* and *death armor* already cast from scrolls. He then reverts to his swarm form to gain an element of surprise. When he reveals himself for the first time, read:

The various flopping, flying, squelching body parts rapidly come together, forming a humanoid creature in tattered wrappings. A chain hangs round its neck bearing a diamond-shaped pendant containing a sickly green and yellow eye within.

The creature croaks forth something in a nearly forgotten language and rejoins the melee.

Herceptus routinely speaks in Flan. His short vocalization was a grateful prayer to Incabulos for sending him fresh test subjects. Herceptus the Undying uses spells combined with his metamagic feat to his greatest advantage.

When not threatened, Herceptus uses his *robe of bones* (DMG 265) to add additional undead to the battle, beginning with the human commoner skeletons. Should PCs engage him directly, Herceptus transforms back into a swarm of parts. Should the battle desperately go against him, he flings himself into the sarcophagus, closing the lid, then opening the hidden panel out of sight of the PCs. Herceptus is willing to sacrifice himself rather than allow the PCs to capture his hidden treasures.

The necrosis carnex attack and seek to keep Herceptus healed. The necrosis carnex shy away from any PC who makes a successful attack with a good-aligned weapon.

DEVELOPMENT

Defeating the undead allows PCs to search the fetid crypt. This entire area has been converted into a repulsive necromancer's laboratory. There is nothing useful in the laboratory for anyone of sane mind. A DC 15 Search check, turns up a piece of parchment with writing in Ancient Suloise. The parchment is a progress report written by Herceptus the Undying to someone or something called Envira. Elsewhere in the progress report, Herceptus refers to "My Mistress of Pox". A DC 15

Knowledge (religion) check identifies that as an honorific for a well-respected follower of Incabulos.

Treasure: Deduct gold for any consumables used by Herceptus the Undying during the battle. The *unguent of timelessness* was previously applied to Herceptus' body and is never available as loot. Refer to the Treasure Summary to determine what the PCs find here.

TRAPPED SARCOPHAGUS

Opening the sarcophagus does not activate a trap. A Search check, DC 20+APL of the sarcophagus reveals a hidden panel in the bottom. The panel is trapped. In the case of the magical traps, the *alarm* spell activates the trap if the panel is touched without providing a pass phrase (in Flan).

APL 2 (EL 1)

➤ **Basic Arrow Trap:** CR 1; mechanical; touch trigger; manual reset; Atk +10 ranged (1d6/x3, arrow); Search DC 18; Disable Device DC 18.

APL 4 (EL 2)

➤ **Javelin Trap:** CR 2; mechanical; touch trigger; manual reset; Atk +15 ranged (1d6+4, javelin); Search DC 20; Disable Device DC 20.

APL 6 (EL 3)

➤ **Burning Hands Trap:** CR 3; magic device; touch trigger (*alarm*); automatic reset; spell effect (*burning hands (cold substituted)*), 5th-level wizard, 5d4 cold, DC 11 Reflex save half damage); Search DC 26; Disable Device DC 26.

APL 8 (EL 4)

➤ **Lightning Bolt Trap:** CR 4; magic device; touch trigger (*alarm*); automatic reset; spell effect (*lightning bolt*), 5th-level wizard, 5d6 electricity, DC 14 Reflex save half damage); Search DC 28; Disable Device DC 28

Within the sarcophagus are some chunks of shiny rock. Retrieving these grants PCs access to Star Metal Find and Raw Ores rewards on the AR.

CONCLUSION

Returning to Wartower Warden's guild house what loot was liberated is carefully examined by Stillguar. The dwarven leader extracts his percentage and asks for your tale.

Hopefully your explorations have proven useful and other parties of adventurers can carry forward, perhaps solving additional mysteries surrounding this cryptic death trap.

Stillguar's percentage is innate to the treasure and should not be subtracted to what is calculated in the module.

EXPERIENCE POINT SUMMARY

To award experience for this adventure, add up the values for the objectives accomplished. Then assign the experience award. Award the total value (objectives plus roleplaying) to each character.

Encounter 1

Disable, destroy, or escape the spell turret trap.

APL 2	30 XP
APL 4	60 XP
APL 6	90 XP
APL 8	120 XP

Encountering and defeating the Minions of Iuz ambush.

APL 2	120 XP
APL 4	180 XP
APL 6	240 XP
APL 8	300 XP

Encounter 2

Defeating the undead in the temple sanctuary.

APL 2	90 XP
APL 4	150 XP
APL 6	210 XP
APL 8	270 XP

Encounter 3

Defeating the Herceptus the Unliving and minion(s).

APL 2	180 XP
APL 4	240 XP
APL 6	300 XP
APL 8	360 XP

Encountering the sarcophagus trap.

APL 2	30 XP
APL 4	60 XP
APL 6	90 XP
APL 8	120 XP

Story Award

Consecrate the ancient Temple of Pelor:

APL 2	60 XP
APL 4	90 XP
APL 6	120 XP
APL 8	150 XP

Identifying the temple's original patron deity:

APL 2	15 XP
APL 4	15 XP
APL 6	15 XP
APL 8	15 XP

Discovering the access way to the catacombs:

APL 2	15 XP
APL 4	30 XP
APL 6	45 XP

APL 8

60 XP

Maximum possible experience:

APL 2	450 XP
APL 4	675 XP
APL 6	900 XP
APL 8	1,125 XP

TREASURE SUMMARY

During an adventure, characters encounter treasure, usually finding it in the possession of their foes. Every encounter that features treasure has a "treasure" section within the encounter description, giving information about the loot, coins, and magic items that make up the encounter's treasure.

The loot total is the number of gold pieces each character gains if the foes are plundered of all their earthly possessions. Looting the bodies takes at least 10 minutes per every 5 enemies, and if the characters cannot take the time to loot the bodies, they do not gain this gold. If you feel it is reasonable that characters can go back to loot the bodies, and those bodies are there (i.e., not carted off by dungeon scavengers, removed from the scene by the local watch, and so on), characters may return to retrieve loot. If the characters do not loot the body, the gold piece value for the loot is subtracted from the encounter totals given below.

The coin total is the number of gold pieces each character gains if they take the coin available. A normal adventuring party can usually gather this wealth in a round or so. If for some reason, they pass up this treasure, the coin total is subtracted from the encounter totals given below.

Next, the magic items are listed. Magic item treasure is the hardest to adjudicate, because they are varied and because characters may want to use them during the adventure. Many times characters must cast identify, analyze dweomer or similar spell to determine what the item does and how to activate it. Other times they may attempt to use the item blindly. If the magic item is consumable (a potion, scroll, magic bolts, etc.) and the item is used before the end of the adventure, its total is subtracted from the adventure totals below.

Once you have subtracted the value for unclaimed treasure from each encounter add it up and that is the number of gold pieces a characters total and coin value increase at the end of the adventure. Write the total in the GP Gained field of the adventure certificate.

Loot = Looted gear from enemy; Coin = Coin, Gems, Jewelry, and other valuables; Magic = Magic Items.

Encounter 1: The Statue of Pelor

APL 2: Coin – 20 gp each (in gems), Loot – 25 gp (demonic trinkets). Total: 45 gp.

APL 4: Coin – 15 gp each (in gems), Loot – 71 gp (demonic trinkets, mundane items), Magic – 17 gp; *oil of magic weapon* (4 gp), *scroll of sound burst* (13 gp). Total: 103 gp.

APL 6: Coin – 10 gp each (in gems), Loot – 84 gp (demonic trinkets, mundane items), Magic – 17 gp; *oil of magic weapon* (4 gp), *scroll of sound burst* (13 gp). Total: 111 gp.

APL 8: Coin – 5 gp each (in gems), Loot – 38 gp (demonic trinkets), Magic – 928 gp; *scroll of heal* (138 gp), *wand of searing light* (CL 5th, 11 charges) (206 gp), *ring of protection +1* (167 gp), +1 *full plate* (221 gp), +1 *greatsword* (196 gp). Total 971 gp.

Encounter 2: The Ancient Temple of Pelor

APL 2: Magic – 75 gp; *oil of bless weapon* (8 gp), *potion of aid* (25 gp), *potion of cure light wounds* (4 gp), *potion of cure light wounds* (4 gp), *potion of cure light wounds* (4 gp), *potion of cure moderate wounds* (25 gp), *potion of shield of faith* (+2) (4 gp).

APL 4: Magic – 95 gp; *oil of bless weapon* (8 gp), *potion of aid* (25 gp), *potion of bear's endurance* (25 gp), *potion of cure light wounds* (4 gp), *potion of cure light wounds* (4 gp), *potion of cure moderate wounds* (25 gp), *potion of shield of faith* (+2) (4 gp).

APL 6: Magic – 196 gp; *oil of bless weapon* (8 gp), *potion of aid* (25 gp), *potion of bear's endurance* (25 gp), *potion of cure moderate wounds* (25 gp), *potion of cure moderate wounds* (25 gp), *potion of cure serious wounds* (63 gp), *potion of shield of faith* (+3) (25 gp).

APL 8: Magic – 297 gp; *oil of bless weapon* (8 gp), *potion of aid* (25 gp), *potion of bear's endurance* (25 gp), *potion of cure serious wounds* (63 gp), *potion of cure serious wounds* (63 gp), *potion of cure serious wounds* (63 gp), *potion of shield of faith* (+4) (50 gp).

Encounter 3: The Crypt

APL 2: Magic – 254 gp; *arcane scroll of death armor* (17 gp), *arcane scroll of resist energy* (13 gp), *bracers of armor +1* (83 gp), *elixir of hiding* (21 gp), *robe of bones* (200 gp).

APL 4: Magic – 488 gp; *arcane scroll of death armor* (CL5) (25 gp), *arcane scroll of resist energy* (CL5) (21 gp), *bracers of armor +1* (83 gp), *elixir of hiding* (21 gp), *robe of bones* (200 gp), *necklace of fireballs* (type I) (138 gp).

APL 6: Magic – 841 gp; *arcane scroll of death armor* (CL7) (33 gp), *arcane scroll of resist energy* (CL7) (29 gp), *bracers of armor +2* (333 gp), *elixir of hiding* (21 gp), *necklace of fireballs* (type II) (225 gp), *robe of bones* (200 gp).

APL 8: Magic – 1,372 gp; *arcane scroll of death armor* (CL9) (42 gp), *arcane scroll of resist energy* (CL9) (38 gp), *aroma of curdled death* (375 gp), *bracers of armor +2* (333 gp), *elixir of hiding* (21 gp), *necklace of fireballs* (type III) (363 gp), *robe of bones* (200 gp).

Total Possible Treasure

APL 2: Coin: 20 gp; Loot: 25 gp; Magic: 409 gp; Total: 454 gp (450 gp max).

APL 4: Coin: 15 gp; Loot: 71 gp; Magic: 600 gp; Total: 686 gp (650 gp max).

APL 6: Coin: 10 gp; Loot: 84 gp; Magic: 1054 gp; Total: 1148 gp (900 gp max).

APL 8: Coin: 5 gp; Loot: 38 gp; Magic: 2597 gp; Total: 2640 gp (1300 gp max).

SPECIAL

The PCs may gain the following AR items in this adventure:

Star Metal Find: PCs finding the metals in Herceptus' sarcophagus gain this AR item.

Raw Ores: finding the metals in Herceptus' sarcophagus gain this AR item.

Cleansing of the Sun: PCs cleansing the ancient temple of Pelor gain this AR item.

Favor of High Matriarch Sarana: PCs cleansing the ancient temple of Pelor gain this AR item.

Affiliation Score Gained/Lost: PCs that succeed in cleansing the temple gain 1 affiliation point with the affiliation of their choice. PCs failing to cleanse the temple lose an affiliation point with the affiliation with which they have the highest score.

☛ **Cleansing of the Sun** – You have cleansing an ancient temple of the sun god, Pelor, and consequently gain access to the limited prestige classes *master of radiance* (page 44) and *sacred purifier* (page 49) from *Libris Mortis*.

☛ **Favor of High Matriarch Sarana:** Blessings are showered upon you. Sarana is very happy with you and blesses you with Pelor's bounty. Consequently you may once, as a standard action, cast *daylight* (CL = your level).

She will also waive any costs (except material component costs) casting a single cleric conjuration (healing) spell from the PH.

☛ **Star Metal Find:** You have found enough starmetal to gain one level in the green star adept prestige class (*Complete Arcana* 41). Alternatively, you can use the ore to make one weapon or suit of armor.

☛ **Raw Ores:** You have found enough mithral to make one suit of armor and enough adamantite to make one weapon or suit of armor. You must still pay all relevant costs finding a skilled armorer or weaponsmith.

☛ **Affiliation Score Gained/ Lost:** You have gained/lost ___ points with the ___ affiliation. If you are affiliated with more than one group, add extra notes in the notes section detailing your gain or loss.

ITEMS FOR THE ADVENTURE RECORD

Item Access

APL 2:

Elixir of hiding (Adventure; 250 gp).

Robe of bones (Adventure; 2,400 gp).

Scroll of death armor (Adventure; 200 gp).

APL 4 (all of APL 2 plus the following):

Necklace of fireballs (cold substituted) Type I (Adventure; 1,650 gp).
Scroll of death armor (CL 5th) (Adventure; 300 gp).
Scroll of resist energy (CL 5th) (Adventure; 250 gp).

APL 6 (all of APLs 2-4 plus the following):

Necklace of fireballs (cold substituted) Type II (Adventure; 2,700 gp).
Scroll of death armor (CL 7th) (Adventure; 400 gp).
Scroll of resist energy (CL 7th) (Adventure; 350 gp).

APL 8 (all of APL 2-6 plus the following):

Aroma of curdled death (Adventure; *Complete Arcane*; 4,500 gp).
Bracers of armor +2 (Adventure; 4,000 gp).
Necklace of fireballs (cold substituted) Type III (Adventure; 4,350 gp).
Scroll of death armor (CL 9th) (Adventure; 500 gp).
Scroll of heal (Adventure; 1,650 gp).
Scroll of resist energy (CL 9th) (Adventure; 450 gp).
Wand of searing light (Adventure; 2,475 gp).

APPENDIX 1: APL 2

2: THE ANCIENT TEMPLE OF PELOR

HUMAN WARRIOR SKELETON CR 1/3

NE Medium undead (augmented humanoid)
Init +5; **Senses** darkvision 60 ft., Listen +0, Spot +0
Languages —

AC 15, touch 11, flat-footed 14
(+1 Dex, +2 shield, +2 natural)
hp 6 (1 HD); 7 hp with *desecrate*; **DR** 5/bludgeoning
Immune cold, undead immunities
Fort +2, **Ref** +3, **Will** +4 with *desecrate*

Speed 30 ft. (6 squares)
Melee scimitar +2 (1d6+2/18-20) or
2 claws +2 each (1d4+2, claw) with *desecrate*
Base Atk +0; **Grp** +1

Abilities Str 13, Dex 13, Con —; Int —, Wis 10, Cha 1
Feats Improved Initiative
Possessions Heavy steel shield, scimitar

REVIVED FOSSIL* HUMAN CLERIC CR 1

**Libris Mortis* 118
NE Medium undead (augmented humanoid)
Init +1; **Senses** darkvision 60 ft., Listen +0, Spot +0
Languages —

AC 23, touch 11, flat-footed 22
(+1 Dex, +12 natural)
hp 26 (1 HD); 27 hp with *desecrate*; **DR** 10/adamantine
Immune cold, undead immunities
Fort +2, **Ref** +3, **Will** +4 with *desecrate*

Speed 30 ft. (6 squares)
Melee 2 claws +3 (2d6+3) with *desecrate*
Base Atk +0; **Grp** +2
Abilities Str 14, Dex 12, Con —; Int —, Wis 10, Cha 1
SQ undead traits
Feats Combat Reflexes

3: THE CRYPT

NECROSIS CARNEX* CR 3

**Monster Manual IV* 104
NE Medium undead
Init +3; **Senses** darkvision 60 ft.; Listen +5, Spot +4
Aura malign (30 ft.)
Languages understands creator's orders

AC 21, touch 17, flat-footed 18; Mobility
(+3 Dex, +4 natural, +4 deflection)
hp 26 (4 HD)
Immune undead immunities
Fort +3, **Ref** +4, **Will** +5
Weakness vulnerability to good

Speed 40 ft. (8 squares)
Melee touch +5 (1d6+2)
Base Atk +2; **Grp** +3
Atk Options necrotic touch
Special Actions unholy burst

Abilities Str 12, Dex 17, Con —, Int 3, Wis 12, Cha 7
SQ undead traits

Feats Great Fortitude, Mobility, Weapon Finesse
Skills Jump +5, Listen +5, Spot +4

Malign Aura (Su) Living creatures take a -2 penalty on attack rolls and saving throws when they are within 30 feet of a necrosis carnex.

Necrotic Touch (Su) If a necrosis carnex hits a living creature with its touch attack, it deals damage equal to 1d6+1 per 2 HD of the necrosis carnex. Undead are instead healed by the same amount, gaining any hit points over their full normal total as temporary hit points that last for up to 10 minutes.

Unholy Burst (Ex) When destroyed, a necrosis carnex explodes in a 30-foot-radius spread that deals damage equal to 1d6+1 per 2 HD of the necrosis carnex to all living creatures in the area. Undead are instead healed by the same amount, gaining any hit points over their normal total as temporary hit points, as described above.

Vulnerability to Good (Ex) Necrosis carnexes take half again as much (+50%) damage as normal from good-aligned weapons and spells.

Description: *The creature before you is a horrid amalgam of rotting flesh bound to twisted limbs. It walks on all four of its awkward appendages, and great bands of black iron seem to hold the various pieces of putrid tissue together.*

A necrosis carnex is a ghastly collection of corpse-flesh bound together into an engine of destruction. It is something like an undead flesh golem, but it retains a glimmer of intelligence and can follow simple orders. Necrosis carnexes serve undead armies as both shock troops and combat medics.

HERCEPTUS THE UNDYING CR 5

Swarm-shifter* mummified** male human sorcerer 1
**Libris Mortis* 123
***Libris Mortis* 110

NE Medium undead (augmented human, shapechanger)
Init +1; **Senses** darkvision 60 ft.; Listen +2, Spot +2
Languages Ancient Suloise, Draconic, Flan

AC 22, touch 11, flat-footed 21
(+1 Dex, +1 armor, +10 natural)
hp 12 (1 HD); **DR** 5/-
Immune undead immunities
Resist fire 10 with *resist energy (fire)*
Fort +1, **Ref** +2, **Will** +5 with *unguent of timelessness*
Weakness vulnerability to fire

Speed 20 ft. (4 squares)
Melee slam +3 (1d8+4)
Base Atk +0; **Grp** +3
Atk Options mummy rot
Special Actions despair, swarm form
Combat Gear *arcane scroll of resist energy* (CL 3),
arcane scroll of death armor (CL 3), *elixir of hiding*,
robe of bones

Sorcerer Spells Known (CL 1st):
1st (4/day)—backbiter (DC 16), *ray of enfeeblement*

0 (5/day)—*acid splash*, *daze* (DC 14), *detect magic*,
touch of fatigue (DC 15)

Abilities Str 16, Dex 12, Con —, Int 12, Wis 14, Cha 19.
SQ undead traits

Feats Fell Weaken, Spell Focus (necromancy)

Skills Concentration +8, Knowledge (arcana) +5,
Knowledge (religion) +2, Move Silently +2, Spellcraft
+5

Possessions combat gear plus *bracers of armor* +1

Vulnerability to Fire (Ex) A mummy takes half again as much (+50%) damage as normal from fire, regardless of whether a saving throw is allowed, or if the save is a success or failure.

Despair (Su) At the mere sight of a mummified creature, the viewer must make a successful Will save (DC 14) or be paralyzed with fear for 1d4 rounds. Whether or not the save is successful, that target cannot be affected again by that mummy's despair ability for 24 hours.

Mummy Rot (Su) Supernatural disease—natural weapons, Fortitude DC 14, incubation period 1 minute; damage 1d6 Con and 1d6 Cha.

Unlike normal diseases, mummy rot continues until the victim reaches Constitution 0 (and dies) or is cured as described below.

Mummy rot is a powerful curse, not a natural disease. A character attempting to cast any conjuration (healing) spell on a creature afflicted with mummy rot must succeed on a DC 20 caster level check, or the spell has no effect on the afflicted character.

To eliminate mummy rot, the curse must first be broken with *break enchantment* or *remove curse* (requiring a DC 20 caster level check for either spell), after which a caster level check is no longer necessary to cast healing spells on the victim, and the mummy rot can be magically cured as any normal disease.

An afflicted creature that dies of mummy rot shrivels away into sand and dust that blow away into nothing at the first wind.

Swarm Form (Su) Herceptus is able to turn into a swarm of body parts with the statistics listed below. Changing shape to or from swarm form is a standard action that infuses Herceptus with negative energy and heals 4 hit points of damage. As with the *alter self* spell, the base creature's items are absorbed into the swarm form and provide no benefit. When it would normally be dispersed due to damage taken, the swarm reverts to base creature and is destroyed.

Although use of this ability is a supernatural effect, remaining in one form or another is not supernatural, and the base creature is swarm form does not change into its normal shape in an *antimagic field*. *True seeing* and similar magic reveal both forms.

HERCEPTUS THE UNDYING (SWARM FORM) CR 5

Swarm-shifter* mummified** male human sorcerer 1

**Libris Mortis* 123

***Libris Mortis* 110

NE Tiny undead (swarm)

Init +1; **Senses** darkvision 60 ft.; Listen, Spot

Languages Draconic, Flan, Ancient Suloise

AC 26, touch 15, flat-footed 23

(+2 size, +3 Dex, +1 armor, +10 natural)

hp 12 (1 HD); **DR** 5/-, half damage from slashing and piercing weapons

Immune undead immunities

Resist fire 10 with *resist energy (fire)*

Fort +1, **Ref** +4, **Will** +5 with *unguent of timelessness*

Weakness vulnerability to fire

Speed 20 ft., fly 20 ft. (poor) (4 squares)

Melee swarm (2d6)

Space 10 ft.; **Reach** 0 ft.

Base Atk +0; **Grp** —

Atk Options distraction, mummy rot, parts

Special Actions fear, swarm form

Abilities Str 8, Dex 16, Con —, Int 12, Wis 14, Cha 19.

SQ hive mind, undead traits

Skills Concentration +8, Disguise +14, Knowledge (arcana) +5, Knowledge (religion) +2, Move Silently +4, Spellcraft +5

Distraction (Ex) Any living creature vulnerable to a swarm's damage that begins its turn with the swarm in its square is nauseated for 1 round; a Fortitude save, DC 14, negates the effect. Even with a successful save, spellcasting or concentrating on spells within the area of a swarm requires a Concentration check. Using skills requiring patience and concentration requires a DC 20 Concentration check. The save DC is Charisma-based.

Fear (Su) A creature damaged by a parts swarm must make a successful Will save, DC 14, or be frightened for 1d4 rounds. The save DC is Charisma-based.

Hive Mind (Ex) A swarm-shifter with this ability is immune to any spell or effect that targets a specific number of creatures with the exception of effects that command, control, turn, rebuke, bolster, or destroy undead specifically. A swarm-shifter in swarm form is affected by turn and rebuke attempts just like the base creature.

Parts (Ex) A parts swarm undead is a swarm made up of the body parts of the undead creature. This causes the swarm to deal an extra 1d6 points of damage with its swarm attack.

Swarm (Ex) Swarms deal automatic damage to any creature whose space they occupy at the end of their move, with no attack roll needed. Swarm attacks are not subject to a miss chance for concealment or cover. Swarms do not threaten creatures in their square, and do not make attacks of opportunity with their swarm attack.

1: THE STATUE OF PELOR

ACOYLTE OF IUZ

CR 4

Male human cleric 4

CE Medium humanoid

Init +0; Senses Listen +2, Spot +2

Languages Common

AC 16, touch 10, flat-footed 16

hp 31 (4 HD)

Fort +6, Ref +3, Will +6 with *bless*; +1 against fear with *bless*

Speed 20 ft. in splint mail (4 squares), base speed 30 ft.

Melee mwk greatsword +9 (2d6+6/19-20) with *bull's strength* and *bless*

Base Atk +3; Grp +7 with *bull's strength*

Special Actions rebuke undead 4/day (+1, 2d6+5, 4th), spontaneous casting (*inflict* spells)

Combat Gear *oil of magic weapon*, *scroll of sound burst*

Cleric Spells Prepared (CL 4th):

2nd—*bull's strength*[†], *cure moderate wounds*, *invisibility*^D, *spiritual weapon*

1st—*bless*[†], *command* (DC 13), *cure light wounds*, *protection from good*^D (CL 5th), *doom* (DC 13)

0—*cure minor wounds* (2), *detect magic*, *guidance*, *read magic*

D: Domain spell. Deity: Iuz. Domains: Evil, Trickery

†Already cast

Abilities Str 18 with *bull's strength*, Dex 10, Con 14, Int 8, Wis 15, Cha 12

Feats Combat Casting, Martial Weapon Proficiency (greatsword), Lightning Reflexes

Skills Bluff +6, Concentration +9 (+13 casting defensively), Knowledge (religion) +1

Possessions combat gear plus splint mail, masterwork greatsword, silver holy symbol, vestments

2: THE ANCIENT TEMPLE OF PELOR

HUMAN WARRIOR SKELETON

CR 1/3

NE Medium undead (augmented humanoid)

Init +5; Senses darkvision 60 ft., Listen +0, Spot +0

Languages —

AC 15, touch 11, flat-footed 14

(+1 Dex, +2 shield, +2 natural)

hp 6 (1 HD); 7 hp with *desecrate*; DR 5/bludgeoning

Immune cold, undead immunities

Fort +2, Ref +3, Will +4 with *desecrate*

Speed 30 ft. (6 squares)

Melee scimitar +2 (1d6+2/18-20) or

2 claws +2 each (1d4+2, claw) with *desecrate*

Base Atk +0; Grp +1

Abilities Str 13, Dex 13, Con —; Int —, Wis 10, Cha 1

Feats Improved Initiative

Possessions Heavy steel shield, scimitar.

REVIVED FOSSIL* HUMAN CLERIC

CR 1

**Libris Mortis* 118

NE Medium undead (augmented humanoid)

Init +1; Senses darkvision 60 ft., Listen +0, Spot +0

Languages —

AC 23, touch 11, flat-footed 22

(+1 Dex, +12 natural)

hp 26 (1 HD); 27 hp with *desecrate*; DR 10/adamantine

Immune cold, undead immunities

Fort +2, Ref +3, Will +4 with *desecrate*

Speed 30 ft. (6 squares)

Melee 2 claws +3 (2d6+3) with *desecrate*

Base Atk +0; Grp +2

Abilities Str 14, Dex 12, Con —; Int —, Wis 10, Cha 1

SQ undead traits

Feats Combat Reflexes

PLAGUE WALKER*

CR 3

**Monster Manual IV* 120

CE Medium undead

Init -2; Senses darkvision 60 ft.; Listen +10, Spot +1

Languages understands creator's orders

AC 12, touch 8, flat-footed 12; bloated target

(-2 Dex, +4 natural)

hp 42 (6 HD); 48 hp with *desecrate*

Immune undead immunities

Fort +3, Ref +1, Will +7 with *desecrate*

Speed 20 ft. (4 squares)

Melee 2 claws +9 (1d6+5 plus diseased touch) with *desecrate*

Base Atk +3; Grp +7

Atk Options diseased touch; +1 profane bonus on attack and damage rolls with *desecrate*

Special Actions putrid blast

Abilities Str 18, Dex 6, Con —, Int 4, Wis 13, Cha 3

SQ undead traits

Feats Skill Focus (Listen), Toughness, Weapon Focus (claw)

Skills Climb +7, Listen +10, Spot +1

Bloated Target (Ex) The -4 penalty for firing into melee does not apply to ranged attacks made against a plague walker. This penalty does, however, apply to other creatures in melee with it.

Diseased Touch (Su) Any living creature struck by a plague walker's claws must succeed on a DC 13 Fortitude save or be overcome by racking pain and nausea, causing that creature to become sickened for 1 minute. The save DC is Constitution-based. Creatures that have immunity to disease are not affected by this ability.

Putrid Burst (Ex) When reduced to one-quarter of its starting hit points or fewer, a plague walker can use a swift action to explode. This burst has a 30-foot radius and deals 3d6 points of damage to everything in the area. All living creatures in the area are nauseated for 1 round; a DC 15 Reflex save halves the damage and negates the nauseated effect. The save DC is Constitution-based and includes a +2 racial bonus.

If reduced to 0 hit points before it can activate its putrid burst, a plague walker simply dissolves into a pile of rotting flesh.

Physical Description: *Staggering forward with an uneven gait, this moving corpse is a large sphere of bloated, rotting flesh. Its bloodshot eyes dart back and forth, and a gurgling sound issues from deep in its throat.*

A plague walker is an undead weapon created by evil mages and clerics. Its tortured body is filled with rotting flesh, diseased matter, and other putrid filth. In battle, it can explode when sufficiently injured, showering the area around it with sickening debris.

3: THE CRYPT

NECROSIS CARNEX* CR 3

**Monster Manual IV* 104

NE Medium undead

Init +3; **Senses** darkvision 60 ft.; Listen +5, Spot +4

Aura malign (30 ft.)

Languages understands creator's orders

AC 21, touch 17, flat-footed 18; Mobility (+3 Dex, +4 natural, +4 deflection)

hp 26 (4 HD)

Immune undead immunities

Fort +3, **Ref** +4, **Will** +5

Weakness vulnerability to good

Speed 40 ft. (8 squares)

Melee touch +5 (1d6+2)

Base Atk +2; **Grp** +3

Atk Options necrotic touch

Special Actions unholy burst

Abilities Str 12, Dex 17, Con —, Int 3, Wis 12, Cha 7

SQ undead traits

Feats Great Fortitude, Mobility, Weapon Finesse

Skills Jump +5, Listen +5, Spot +4

Malign Aura (Su) Living creatures take a -2 penalty on attack rolls and saving throws when they are within 30 feet of a necrosis carnex.

Necrotic Touch (Su) If a necrosis carnex hits a living creature with its touch attack, it deals damage equal to 1d6+1 per 2 HD of the necrosis carnex. Undead are instead healed by the same amount, gaining any hit points over their full normal total as temporary hit points that last for up to 10 minutes.

Unholy Burst (Ex) When destroyed, a necrosis carnex explodes in a 30-foot-radius spread that deals damage equal to 1d6+1 per 2 HD of the necrosis carnex to all living creatures in the area. Undead are instead healed by the same amount, gaining any hit points over their normal total as temporary hit points, as described above.

Vulnerability to Good (Ex) Necrosis carnexes take half again as much (+50%) damage as normal from good-aligned weapons and spells.

Description: *The creature before you is a horrid amalgam of rotting flesh bound to twisted limbs. It walks on all four of its awkward appendages, and great bands of black iron seem to hold the various pieces of putrid tissue together.*

A necrosis carnex is a ghastly collection of corpse-flesh bound together into an engine of destruction. It is something like an undead flesh golem, but it retains a glimmer of intelligence and can follow simple orders. Necrosis carnexes serve undead armies as both shock troops and combat medics.

HERCEPTUS THE UNDYING CR 7

Swarm-shifter* mummified* male human sorcerer 3

**Libris Mortis* 123

***Libris Mortis* 110

NE Medium undead (augmented human, shapechanger)

Init +1; **Senses** darkvision 60 ft.; Listen +2, Spot +2

Languages Ancient Suloise, Draconic, Flan

AC 22, touch 11, flat-footed 21

(+1 Dex, +1 armor, +10 natural)

hp 26 (3 HD); **DR** 5/-

Immune undead immunities

Resist fire 10 with *resist energy (fire)*

Fort +2, **Ref** +3, **Will** +6 with *unqueng of timelessness*

Weakness vulnerability to fire

Speed 20 ft. (4 squares)

Melee slam +4 (1d8+4)

Base Atk +1; **Grp** +4

Atk Options mummy rot

Special Actions despair, swarm form

Combat Gear *arcane scroll of resist energy* (CL 5), *arcane scroll of death armor* (CL 5), *elixir of hiding*, *necklace of fireballs (type I)* (cold substituted), *robe of bones*

Sorcerer Spells Known (CL 3rd):

1st (4/day)—*backbiter* (DC 17), *ray of enfeeblement*, *summon undead I*

0 (5/day)—*acid splash*, *caltrops*, *daze* (DC 14), *detect magic*, *touch of fatigue* (DC 16)

Abilities Str 16, Dex 12, Con —, Int 12, Wis 14, Cha 19.

SQ undead traits

Feats Fell Weaken, Greater Spell Focus (necromancy), Spell Focus (necromancy)

Skills Concentration +10, Knowledge (arcana) +7, Knowledge (religion) +2, Move Silently +3, Spellcraft +9

Possessions combat gear plus *bracers of armor +1*

Vulnerability to Fire (Ex) A mummy takes half again as much (+50%) damage as normal from fire, regardless of whether a saving throw is allowed, or if the save is a success or failure.

Despair (Su) At the mere sight of a mummified creature, the viewer must make a successful Will save (DC 15) or be paralyzed with fear for 1d4 rounds. Whether or not the save is successful, that target cannot be affected again by that mummy's despair ability for 24 hours.

Mummy Rot (Su) Supernatural disease—natural weapons, Fortitude DC 15, incubation period 1 minute; damage 1d6 Con and 1d6 Cha.

Unlike normal diseases, mummy rot continues until the victim reaches Constitution 0 (and dies) or is cured as described below.

Mummy rot is a powerful curse, not a natural disease. A character attempting to cast any conjuration (healing) spell on a creature afflicted with mummy rot must succeed on a DC 20 caster level check, or the spell has no effect on the afflicted character.

To eliminate mummy rot, the curse must first be broken with *break enchantment* or *remove curse* (requiring a DC 20 caster level check for either spell), after which a caster level check is no longer necessary to cast healing spells on the victim, and the mummy rot can be magically cured as any normal disease.

An afflicted creature that dies of mummy rot shrivels away into sand and dust that blow away into nothing at the first wind.

Swarm Form (Su) Herceptus is able to turn into a swarm of body parts with the statistics listed below. Changing shape to or from swarm form is a standard action that infuses Herceptus with negative energy and heals 4 hit points of damage. As with the *alter self* spell, the base creature's items are absorbed into the swarm form and provide no benefit. When it would normally be dispersed due to damage taken, the swarm reverts to base creature and is destroyed.

Although use of this ability is a supernatural effect, remaining in one form or another is not supernatural, and the base creature in swarm form does not change into its normal shape in an *antimagic field*. *True seeing* and similar magic reveal both forms.

save, DC 15, negates the effect. Even with a successful save, spellcasting or concentrating on spells within the area of a swarm requires a Concentration check. Using skills requiring patience and concentration requires a DC 20 Concentration check. The save DC is Charisma-based.

Fear (Su) A creature damaged by a parts swarm must make a successful Will save, DC 15, or be frightened for 1d4 rounds. The save DC is Charisma-based.

Hive Mind (Ex) A swarm-shifter with this ability is immune to any spell or effect that targets a specific number of creatures with the exception of effects that command, control, turn, rebuke, bolster, or destroy undead specifically. A swarm-shifter in swarm form is affected by turn and rebuke attempts just like the base creature.

Parts (Ex) A parts swarm undead is a swarm made up of the body parts of the undead creature. This causes the swarm to deal an extra 1d6 points of damage with its swarm attack.

Swarm (Ex) Swarms deal automatic damage to any creature whose space they occupy at the end of their move, with no attack roll needed. Swarm attacks are not subject to a miss chance for concealment or cover. Swarms do not threaten creatures in their square, and do not make attacks of opportunity with their swarm attack.

HERCEPTUS THE UNDYING (SWARM FORM) CR 7

Swarm-shifter* mummified** male human sorcerer 3

**Libris Mortis* 123

***Libris Mortis* 110

NE Tiny undead (swarm)

Init +1; **Senses** darkvision 60 ft.; Listen , Spot

Languages Ancient Suloise, Draconic, Flan

AC 26, touch 15, flat-footed 23

(+2 size, +3 Dex, +1 armor, +10 natural)

hp 26 (3 HD); **DR** 5/-, half damage from slashing and piercing weapons

Immune undead immunities

Resist fire 10 with *resist energy (fire)*

Fort +2, **Ref** +5, **Will** +6 with *unguent of timelessness*

Weakness vulnerability to fire

Speed 20 ft., fly 20 ft. (poor) (4 squares)

Melee swarm (2d6)

Space 10 ft.; **Reach** 0 ft.

Base Atk +0; **Grp** —

Atk Options mummy rot, parts

Special Actions distraction, fear, swarm form

Abilities Str 8, Dex 16, Con —, Int 12, Wis 14, Cha 19.

SQ hive mind, undead traits

Skills Concentration +10, Disguise +14, Knowledge (arcana) +7, Knowledge (religion) +2, Move Silently +5, Spellcraft +9

Distraction (Ex) Any living creature vulnerable to a swarm's damage that begins its turn with the swarm in its square is nauseated for 1 round; a Fortitude

1: THE STATUE OF PELOR

ACOYLTE OF IUZ

CR 4

Male human cleric 4
CE Medium humanoid
Init +0; **Senses** Listen +2, Spot +2
Languages Common

AC 16, touch 10, flat-footed 16
hp 31 (4 HD)
Fort +6, **Ref** +3, **Will** +6 with *bles*; +1 against fear with *bles*

Speed 20 ft. in splint mail (4 squares), base speed 30 ft.
Melee mwk greatsword +9 (2d6+6/19-20) with *bull's strength* and *bles*

Base Atk +3; **Grp** +7 with *bull's strength*
Special Actions rebuke undead 4/day (+1, 2d6+5, 4th), spontaneous casting (*inflict* spells)

Combat Gear *oil of magic weapon*, *scroll of sound burst*
Cleric Spells Prepared (CL 4th):

2nd—*bull's strength*†, *cure moderate wounds*, *invisibility*^D, *spiritual weapon*
1st—*bles*†, *command* (DC 13), *cure light wounds*, *protection from good*^D (CL 5th), *doom* (DC 13)
0—*cure minor wounds* (2), *detect magic*, *guidance*, *read magic*

D: Domain spell. Deity: Iuz. Domains: Evil, Trickery
†Already cast

Abilities Str 18 with *bull's strength*, Dex 10, Con 14, Int 8, Wis 15, Cha 12

Feats Combat Casting, Martial Weapon Proficiency (greatsword), Lightning Reflexes

Skills Bluff +6, Concentration +9 (+13 casting defensively), Knowledge (religion) +1

Possessions combat gear plus splint mail, masterwork greatsword, silver holy symbol, vestments

2: THE ANCIENT TEMPLE OF PELOR

BONE CREATURE* WARRIOR

CR 1

**Book of Vile Darkness* 184
Male human (Flan) warrior 2
NE Medium undead (augmented humanoid)
Init +4; **Senses** darkvision 60 ft.; Listen +3, Spot +3
Languages Flan

AC 20, touch 14, flat-footed 16 (+4 Dex, +4 armor, +2 natural)
hp 19 (2 HD); 21 hp with *desecrate*; **DR** 5/bludgeoning
Immune cold, undead immunities
Fort +4, **Ref** +5, **Will** +2 with *desecrate*

Speed 30 ft. (6 squares)
Melee mwk rapier +8 (1d6+3/18-20) or claw +6/+6 (1d4+2) with *desecrate*
Ranged mwk composite (+2 Str) longbow +8 (1d8+3/x3) with *desecrate*

Base Atk +2; **Grp** +4
Atk Options Point Blank Shot, Precise Shot, +1 profane bonus on attack and damage rolls with *desecrate*

Abilities Str 15, Dex 18, Con —, Int 10, Wis 12, Cha 8
SQ undead traits

Feats Point Blank Shot, Precise Shot, Weapon Finesse^B
Skills Climb +5, Jump +4, Listen +3, Spot +3
Possessions Masterwork chain shirt, masterwork rapier, masterwork composite (+2 Str) longbow, arrows (20).

REVIVED FOSSIL* HUMAN CLERIC

CR 1

**Libris Mortis* 118
NE Medium undead (augmented humanoid)
Init +1; **Senses** darkvision 60 ft., Liset +0, Spot +0
Languages —

AC 23, touch 11, flat-footed 22 (+1 Dex, +12 natural)
hp 26 (1 HD); 27 hp with *desecrate*; **DR** 10/adamantine
Immune cold, undead immunities
Fort +2, **Ref** +3, **Will** +4 with *desecrate*

Speed 30 ft. (6 squares)
Melee 2 claws +3 (2d6+3) with *desecrate*
Base Atk +0; **Grp** +2
Abilities Str 14, Dex 12, Con —, Int —, Wis 10, Cha 1
SQ undead traits
Feats Combat Reflexes

PLAGUE WALKER*

CR 3

**Monster Manual IV* 120
CE Medium undead
Init -2; **Senses** darkvision 60 ft.; Listen +10, Spot +1
Languages understands creator's orders

AC 12, touch 8, flat-footed 12; bloated target (-2 Dex, +4 natural)
hp 42 (6 HD); 48 hp with *desecrate*
Immune undead immunities
Fort +3, **Ref** +1, **Will** +7 with *desecrate*

Speed 20 ft. (4 squares)
Melee 2 claws +9 (1d6+5 plus diseased touch) with *desecrate*
Base Atk +3; **Grp** +7
Atk Options diseased touch; +1 profane bonus on attack and damage rolls with *desecrate*
Special Actions putrid blast

Abilities Str 18, Dex 6, Con —, Int 4, Wis 13, Cha 3
SQ undead traits
Feats Skill Focus (Listen), Toughness, Weapon Focus (claw)
Skills Climb +7, Listen +10, Spot +1

Bloated Target (Ex) The -4 penalty for firing into melee does not apply to ranged attacks made against a plague walker. This penalty does, however, apply to other creatures in melee with it.

Diseased Touch (Su) Any living creature struck by a plague walker's claws must succeed on a DC 13 Fortitude save or be overcome by racking pain and nausea, causing that creature to become sickened for 1 minute. The save DC is Constitution-based. Creatures that have immunity to disease are not affected by this ability.

Putrid Burst (Ex) When reduced to one-quarter of its starting hit points or fewer, a plague walker can use a swift action to explode. This burst has a 30-foot radius and deals 3d6 points of damage to everything in the area. All living creatures in the area are nauseated for 1 round; a DC 15 Reflex save halves the damage and negates the nauseated effect. The save DC is Constitution-based and includes a +2 racial bonus.

If reduced to 0 hit points before it can activate its putrid burst, a plague walker simply dissolves into a pile of rotting flesh.

Physical Description: *Staggering forward with an uneven gait, this moving corpse is a large sphere of bloated, rotting flesh. Its bloodshot eyes dart back and forth, and a gurgling sound issues from deep in its throat.*

A plague walker is an undead weapon created by evil mages and clerics. Its tortured body is filled with rotting flesh, diseased matter, and other putrid filth. In battle, it can explode when sufficiently injured, showering the area around it with sickening debris.

ENCOUNTER 3: THE CRYPT

ADVANCED NECROSIS CARNEX* CR 5

**Monster Manual IV* 104

NE Medium undead

Init +3; **Senses** darkvision 60 ft.; Listen +6, Spot +6

Aura malign (30 ft.)

Languages understands creator's orders

AC 22, touch 16, flat-footed 19; Dodge, Mobility (-1 size, +3 Dex, +6 natural, +4 deflection)

hp 52 (8 HD)

Immune undead immunities

Fort +5, **Ref** +6, **Will** +7

Weakness vulnerability to good

Speed 40 ft. (8 squares)

Melee touch +6 (1d8+4)

Space 10 ft.; **Reach** 10 ft.

Base Atk +4; **Grp** +13

Atk Options necrotic touch

Special Actions unholy burst

Abilities Str 20, Dex 16, Con —, Int 3, Wis 12, Cha 7

SQ undead traits

Feats Dodge, Great Fortitude, Mobility^B, Weapon Finesse

Skills Jump +6, Listen +6, Spot +6

Malign Aura (Su) Living creatures take a -2 penalty on attack rolls and saving throws when they are within 30 feet of a necrosis carnex.

Necrotic Touch (Su) If a necrosis carnex hits a living creature with its touch attack, it deals damage equal to 1d6+1 per 2 HD of the necrosis carnex. Undead are instead healed by the same amount, gaining any hit points over their full normal total as temporary hit points that last for up to 10 minutes.

Unholy Burst (Ex) When destroyed, a necrosis carnex explodes in a 30-foot-radius spread that deals damage equal to 1d6+1 per 2 HD of the necrosis carnex to all living creatures in the area. Undead are instead healed by the same amount, gaining any hit

points over their normal total as temporary hit points, as described above.

Vulnerability to Good (Ex) Necrosis carnexes take half again as much (+50%) damage as normal from good-aligned weapons and spells.

Description: *The creature before you is a horrid amalgam of rotting flesh bound to twisted limbs. It walks on all four of its awkward appendages, and great bands of black iron seem to hold the various pieces of putrid tissue together.*

A necrosis carnex is a ghastly collection of corpse-flesh bound together into an engine of destruction. It is something like an undead flesh golem, but it retains a glimmer of intelligence and can follow simple orders. Necrosis carnexes serve undead armies as both shock troops and combat medics.

HERCEPTUS THE UNDYING CR 9

Swarm-shifter* mummified* male human sorcerer 5

**Libris Mortis* 123

***Libris Mortis* 110

NE Medium undead (augmented human, shapechanger)

Init +1; **Senses** darkvision 60 ft.; Listen +2, Spot +2

Languages Ancient Suloise, Draconic, Flan

AC 23, touch 11, flat-footed 22

(+1 Dex, +2 armor, +10 natural)

hp 40 (5 HD); **DR** 5/-

Immune undead immunities

Resist fire 20 with *resist energy (fire)*

Fort +2, **Ref** +3, **Will** +7 with *unquench of timelessness*

Weakness vulnerability to fire

Speed 20 ft. (4 squares)

Melee slam +5 (1d8+4)

Base Atk +2; **Grp** +5

Atk Options mummy rot

Special Actions despair, swarm form

Combat Gear *arcane scroll of resist energy* (CL 7), *arcane scroll of death armor* (CL 7), *elixir of hiding*, *necklace of fireballs (type II) (cold substituted)*, *robe of bones*

Sorcerer Spells Known (CL 5th):

2nd (5/day)—*blindness/deafness* (DC 19), *stone bones*

1st (8/day)—*backbiter* (DC 18), *magic missile*, *ray of enfeeblement*, *summon undead I*

0 (6/day)—*acid splash*, *caltrops*, *daze* (DC 15), *detect magic*, *slash tongue* (DC 15), *touch of fatigue* (DC 17)

Abilities Str 16, Dex 12, Con —, Int 12, Wis 14, Cha 20

SQ undead traits

Feats Fell Weaken, Greater Spell Focus (necromancy), Spell Focus (necromancy)

Skills Concentration +13, Knowledge (arcana) +8, Knowledge (religion) +3, Move Silently +4, Spellcraft +10

Possessions combat gear plus *bracers of armor* +2

Vulnerability to Fire (Ex) A mummy takes half again as much (+50%) damage as normal from fire, regardless of whether a saving throw is allowed, or if the save is a success or failure.

Despair (Su) At the mere sight of a mummified creature, the viewer must make a successful Will save (DC 17) or be paralyzed with fear for 1d4 rounds. Whether or not the save is successful, that target cannot be affected again by that mummy's despair ability for 24 hours.

Mummy Rot (Su) Supernatural disease—natural weapons, Fortitude DC 17, incubation period 1 minute; damage 1d6 Con and 1d6 Cha.

Unlike normal diseases, mummy rot continues until the victim reaches Constitution 0 (and dies) or is cured as described below.

Mummy rot is a powerful curse, not a natural disease. A character attempting to cast any conjuration (healing) spell on a creature afflicted with mummy rot must succeed on a DC 20 caster level check, or the spell has no effect on the afflicted character.

To eliminate mummy rot, the curse must first be broken with *break enchantment* or *remove curse* (requiring a DC 20 caster level check for either spell), after which a caster level check is no longer necessary to cast healing spells on the victim, and the mummy rot can be magically cured as any normal disease.

An afflicted creature that dies of mummy rot shrivels away into sand and dust that blow away into nothing at the first wind.

Swarm Form (Su) Herceptus is able to turn into a swarm of body parts with the statistics listed below. Changing shape to or from swarm form is a standard action that infuses Herceptus with negative energy and heals 4 hit points of damage. As with the *alter self* spell, the base creature's items are absorbed into the swarm form and provide no benefit. When it would normally be dispersed due to damage taken, the swarm reverts to base creature and is destroyed.

Although use of this ability is a supernatural effect, remaining in one form or another is not supernatural, and the base creature is swarm form does not change into its normal shape in an *antimagic field*. *True seeing* and similar magic reveal both forms.

Melee swarm (2d6)

Space 10 ft.; **Reach** 0 ft.

Base Atk +0; **Grp** —

Atk Options distraction, mummy rot, parts

Special Actions fear, swarm form

Abilities Str 8, Dex 16, Con —, Int 12, Wis 14, Cha 20
SQ hive mind, undead traits

Feats —

Skills Concentration +13, Disguise +15, Knowledge (arcana) +8, Knowledge (religion) +3, Move Silently +6, Spellcraft +10

Distraction (Ex) Any living creature vulnerable to a swarm's damage that begins its turn with the swarm in its square is nauseated for 1 round; a Fortitude save, DC 17, negates the effect. Even with a successful save, spellcasting or concentrating on spells within the area of a swarm requires a Concentration check. Using skills requiring patience and concentration requires a DC 20 Concentration check. The save DC is Charisma-based.

Fear (Su) A creature damaged by a parts swarm must make a successful Will save, DC 17, or be frightened for 1d4 rounds. The save DC is Charisma-based.

Hive Mind (Ex) A swarm-shifter with this ability is immune to any spell or effect that targets a specific number of creatures with the exception of effects that command, control, turn, rebuke, bolster, or destroy undead specifically. A swarm-shifter in swarm form is affected by turn and rebuke attempts just like the base creature.

Parts (Ex) A parts swarm undead is a swarm made up of the body parts of the undead creature. This causes the swarm to deal an extra 1d6 points of damage with its swarm attack.

Swarm (Ex) Swarms deal automatic damage to any creature whose space they occupy at the end of their move, with no attack roll needed. Swarm attacks are not subject to a miss chance for concealment or cover. Swarms do not threaten creatures in their square, and do not make attacks of opportunity with their swarm attack.

HERCEPTUS THE UNDYING (SWARM FORM) CR 9

Swarm-shifter* mummified** male human sorcerer 5

**Libris Mortis* 123

***Libris Mortis* 110

NE Tiny undead (swarm)

Init +3; **Senses** darkvision 60 ft.; Listen +2, Spot +2

Languages Ancient Suloise, Draconic, Flan

AC 27, touch 15, flat-footed 24

(+2 size, +3 Dex, +2 armor, +10 natural)

hp 40 (5 HD); **DR** 5/-, half damage from slashing and piercing weapons

Immune undead immunities

Resist fire 20 with *resist energy (fire)*

Fort +2, **Ref** +5, **Will** +6 with *unguent of timelessness*

Weakness vulnerability to fire

Speed 20 ft., fly 20 ft. (poor) (4 squares)

1: THE STATUE OF PELOR**SERVITOR OF IUZ****CR 8**

Male human cleric 8

CE Medium humanoid

Init -1; **Senses** Listen +4, Spot +4**Languages** Common**AC** 19, touch 10, flat-footed 19**hp** 67 (8 HD)**Fort** +9, **Ref** +4, **Will** +10 with *prayer***Speed** 20 ft. in +1 *full plate* (4 squares), base speed 30 ft.**Melee** +1 *greatsword* +15/+10 (2d6+9/19-20) with *bull's strength*, *divine power* and *prayer***Base Atk** +8; **Grp** +13 with *bull's strength* and *divine power***Atk Options** Power Attack**Special Actions** rebuke undead 4/day (+3, 2d6+9, 8th), spontaneous casting (*inflict* spells), pain touch (domain granted power; see Appendix 5 New Rules Items)**Combat Gear** *scroll of heal*, *wand of searing light* (CL 5th, 11 charges)**Cleric Spells Prepared** (CL 8th):4th—*confusion*^D (DC 17), *divine power*[†], *freedom of movement*3rd—*bestow curse*^D (DC 16), *cure serious wounds*, *dispel magic*, *prayer*[†], *wind wall*2nd—*bull's strength*[†], *cure moderate wounds*, *invisibility*^D, *silence* (DC 15), *spiritual weapon*1st—*command* (2, DC 13), *cure light wounds* (2), *disguise self*^D, *doom* (DC 13)0—*cure minor wounds* (2), *detect magic* (2), *guidance*, *read magic*

D: Domain spell. Deity: Iuz. Domains: Suffering, Trickery

†Already cast

Abilities Str 20 with *bull's strength* and *divine power*, Dex 8, Con 14, Int 10, Wis 16, Cha 12**Feats** Combat Casting, Martial Weapon Proficiency (*greatsword*), Lightning Reflexes, Power Attack**Skills** Bluff +7, Concentration +14 (+18 casting defensively), Knowledge (religion) +7 with *prayer***Possessions** combat gear plus +1 *full plate*, +1 *greatsword*, *ring of protection* +1, silver holy symbol, vestments**2: THE ANCIENT TEMPLE OF PELOR****BONE CREATURE* WARRIOR****CR 2****Book of Vile Darkness* 184

Male human (Flan) warrior 4

NE Medium undead (augmented humanoid)

Init +8; **Senses** darkvision 60 ft.; Listen +4, Spot +4**Languages** Flan**AC** 21, touch 14, flat-footed 17

(+4 Dex, +5 armor, +2 natural)

hp 33 (2 HD); 37 hp with *desecrate*; **DR** 5/bludgeoning**Immune** cold, undead immunities**Fort** +5, **Ref** +6, **Will** +3 with *desecrate***Speed** 30 ft. in *chain shirt* +1 (6 squares)**Melee** mwk rapier +10 (1d6+4/18-20) orclaw +9/+9 (1d4+3) with *desecrate***Ranged** mwk composite (+3 Str) longbow +10(1d8+4/x3) with *desecrate***Base Atk** +4; **Grp** +7**Atk Options** Point Blank Shot, Precise Shot, +1 profane bonus on attack and damage rolls with *desecrate***Abilities** Str 16, Dex 18, Con —, Int 10, Wis 12, Cha 8**SQ** undead traits**Feats** Improved Initiative, Point Blank Shot, Precise Shot, Weapon Finesse^B**Skills** Climb +8, Jump +5, Listen +4, Spot +4**Possessions** *Chain shirt* +1, masterwork rapier, masterwork composite (+3 Str) longbow, arrows (20).**REVIVED FOSSIL* HUMAN CLERIC****CR 1****Libris Mortis* 118

NE Medium undead (augmented humanoid)

Init +1; **Senses** darkvision 60 ft., Listen +0, Spot +0**Languages** —**AC** 23, touch 11, flat-footed 22

(+1 Dex, +12 natural)

hp 26 (1 HD); 27 hp with *desecrate*; **DR** 10/adamantine**Immune** cold, undead immunities**Fort** +2, **Ref** +3, **Will** +4 with *desecrate***Speed** 30 ft. (6 squares)**Melee** 2 claws +3 (2d6+3) with *desecrate***Base Atk** +0; **Grp** +2**Abilities** Str 14, Dex 12, Con —; Int —, Wis 10, Cha 1**SQ** undead traits**Feats** Combat Reflexes**PLAGUE WALKER*****CR 3****Monster Manual IV* 120

CE Medium undead

Init -2; **Senses** darkvision 60 ft.; Listen +10, Spot +1**Languages** understands creator's orders**AC** 12, touch 8, flat-footed 12; bloated target

(-2 Dex, +4 natural)

hp 42 (6 HD); 48 hp with *desecrate***Immune** undead immunities**Fort** +3, **Ref** +1, **Will** +7 with *desecrate***Speed** 20 ft. (4 squares)**Melee** 2 claws +9 (1d6+5 plus diseased touch) with *desecrate***Base Atk** +3; **Grp** +7**Atk Options** diseased touch; +1 profane bonus on attack and damage rolls with *desecrate***Special Actions** putrid blast**Abilities** Str 18, Dex 6, Con —, Int 4, Wis 13, Cha 3**SQ** undead traits**Feats** Skill Focus (Listen), Toughness, Weapon Focus (claw)**Skills** Climb +7, Listen +10, Spot +1

Bloated Target (Ex) The -4 penalty for firing into melee does not apply to ranged attacks made against a plague walker. This penalty does, however, apply to other creatures in melee with it.

Diseased Touch (Su) Any living creature struck by a plague walker's claws must succeed on a DC 13 Fortitude save or be overcome by racking pain and nausea, causing that creature to become sickened for 1 minute. The save DC is Constitution-based. Creatures that have immunity to disease are not affected by this ability.

Putrid Burst (Ex) When reduced to one-quarter of its starting hit points or fewer, a plague walker can use a swift action to explode. This burst has a 30-foot radius and deals 3d6 points of damage to everything in the area. All living creatures in the area are nauseated for 1 round; a DC 15 Reflex save halves the damage and negates the nauseated effect. The save DC is Constitution-based and includes a +2 racial bonus.

If reduced to 0 hit points before it can activate its putrid burst, a plague walker simply dissolves into a pile of rotting flesh.

Physical Description: *Staggering forward with an uneven gait, this moving corpse is a large sphere of bloated, rotting flesh. Its bloodshot eyes dart back and forth, and a gurgling sound issues from deep in its throat.*

A plague walker is an undead weapon created by evil mages and clerics. Its tortured body is filled with rotting flesh, diseased matter, and other putrid filth. In battle, it can explode when sufficiently injured, showering the area around it with sickening debris.

3: THE CRYPT

ADVANCED NECROSIS CARNEX* CR 5

**Monster Manual IV* 104

NE Medium undead

Init +3; **Senses** darkvision 60 ft.; Listen +6, Spot +6

Aura malign (30 ft.)

Languages understands creator's orders

AC 22, touch 16, flat-footed 19; Dodge, Mobility (-1 size, +3 Dex, +6 natural, +4 deflection)

hp 52 (8 HD)

Immune undead immunities

Fort +5, **Ref** +6, **Will** +7

Weakness vulnerability to good

Speed 40 ft. (8 squares)

Melee touch +6 (1d8+4)

Space 10 ft.; **Reach** 10 ft.

Base Atk +4; **Grp** +13

Atk Options necrotic touch

Special Actions unholy burst

Abilities Str 20, Dex 16, Con —, Int 3, Wis 12, Cha 7

SQ undead traits

Feats Dodge, Great Fortitude, Mobility^B, Weapon Finesse

Skills Jump +6, Listen +6, Spot +6

Malign Aura (Su) Living creatures take a -2 penalty on attack rolls and saving throws when they are within 30 feet of a necrosis carnex.

Necrotic Touch (Su) If a necrosis carnex hits a living creature with its touch attack, it deals damage equal to 1d6+1 per 2 HD of the necrosis carnex. Undead are instead healed by the same amount, gaining any hit points over their full normal total as temporary hit points that last for up to 10 minutes.

Unholy Burst (Ex) When destroyed, a necrosis carnex explodes in a 30-foot-radius spread that deals damage equal to 1d6+1 per 2 HD of the necrosis carnex to all living creatures in the area. Undead are instead healed by the same amount, gaining any hit points over their normal total as temporary hit points, as described above.

Vulnerability to Good (Ex) Necrosis carnexes take half again as much (+50%) damage as normal from good-aligned weapons and spells.

Description: *The creature before you is a horrid amalgam of rotting flesh bound to twisted limbs. It walks on all four of its awkward appendages, and great bands of black iron seem to hold the various pieces of putrid tissue together.*

A necrosis carnex is a ghastly collection of corpse-flesh bound together into an engine of destruction. It is something like an undead flesh golem, but it retains a glimmer of intelligence and can follow simple orders. Necrosis carnexes serve undead armies as both shock troops and combat medics.

HERCEPTUS THE UNDYING CR 11

Swarm-shifter* mummified** male human sorcerer 7

**Libris Mortis* 123

***Libris Mortis* 110

NE Medium undead (augmented human, shapechanger)

Init +1; **Senses** darkvision 60 ft.; Listen +2, Spot +2

Languages Ancient Suloise, Draconic, Flan

AC 23, touch 11, flat-footed 22

(+1 Dex, +2 armor, +10 natural)

hp 54 (7 HD); **DR** 5/-

Immune undead immunities

Resist fire 20 with *resist energy (fire)*

Fort +3, **Ref** +4, **Will** +8 with *unqueng of timelessness*

Weakness vulnerability to fire

Speed 20 ft. (4 squares)

Melee slam +6 (1d8+4)

Base Atk +3; **Grp** +6

Atk Options mummy rot

Special Actions despair, swarm form

Combat Gear *arcane scroll of resist energy* (CL 9), *arcane scroll of death armor* (CL 9), *aroma of curdled death*, *elixir of hiding*, *necklace of fireballs (type III) (cold substituted)*, *robe of bones*

Sorcerer Spells Known (CL 7th):

3rd (5/day)—*ray of exhaustion* (DC 20), *vampiric touch*

2nd (7/day)—*blindness/deafness* (DC 19), *stone bones*, *summon undead II*

1st (8/day)—*backbiter* (DC 18), *magic missile*, *ray of enfeeblement*, *spirit worm* (DC 18), *summon undead I*

0 (6/day)—*acid splash*, *caltrops*, *daze* (DC 15), *detect magic*, *slash tongue* (DC 15), *sonic snap* (DC 15), *touch of fatigue* (DC 17)

Abilities Str 16, Dex 12, Con —, Int 12, Wis 14, Cha 20
SQ undead traits

Feats Fell Drain, Fell Weaken, Greater Spell Focus (necromancy), Spell Focus (necromancy)

Skills Concentration +15, Knowledge (arcana) +9, Knowledge (religion) +4, Move Silently +5, Spellcraft +11

Possessions combat gear plus *bracers of armor* +2

Vulnerability to Fire (Ex) A mummy takes half again as much (+50%) damage as normal from fire, regardless of whether a saving throw is allowed, or if the save is a success or failure.

Despair (Su) At the mere sight of a mummified creature, the viewer must make a successful Will save (DC 18) or be paralyzed with fear for 1d4 rounds. Whether or not the save is successful, that target cannot be affected again by that mummy's despair ability for 24 hours.

Mummy Rot (Su) Supernatural disease—natural weapons, Fortitude DC 18, incubation period 1 minute; damage 1d6 Con and 1d6 Cha. Unlike normal diseases, mummy rot continues until the victim reaches Constitution 0 (and dies) or is cured as described below.

Mummy rot is a powerful curse, not a natural disease. A character attempting to cast any conjuration (healing) spell on a creature afflicted with mummy rot must succeed on a DC 20 caster level check, or the spell has no effect on the afflicted character. To eliminate mummy rot, the curse must first be broken with *break enchantment* or *remove curse* (requiring a DC 20 caster level check for either spell), after which a caster level check is no longer necessary to cast healing spells on the victim, and the mummy rot can be magically cured as any normal disease.

An afflicted creature that dies of mummy rot shrivels away into sand and dust that blow away into nothing at the first wind.

Swarm Form (Su) Herceptus is able to turn into a swarm of body parts with the statistics listed below. Changing shape to or from swarm form is a standard action that infuses Herceptus with negative energy and heals 4 hit points of damage. As with the *alter self* spell, the base creature's items are absorbed into the swarm form and provide no benefit. When it would normally be dispersed due to damage taken, the swarm reverts to base creature and is destroyed. Although use of this ability is a supernatural effect, remaining in one form or another is not supernatural, and the base creature in swarm form does not change into its normal shape in an *antimagic field*. *True seeing* and similar magic reveal both forms.

HERCEPTUS THE UNDYING (SWARM FORM) CR 11

Swarm-shifter* mummified** male human sorcerer 7

**Libris Mortis* 123

***Libris Mortis* 110

NE Tiny undead (swarm)

Init +3; **Senses** darkvision 60 ft.; Listen +2, Spot +2

Languages Ancient Suloise, Draconic, Flan

AC 27, touch 15, flat-footed 24

(+2 size, +3 Dex, +2 armor, +10 natural)

hp 54 (7 HD); **DR** 5/-, half damage from slashing and piercing weapons

Immune undead immunities

Resist fire 20 with *resist energy (fire)*

Fort +3, **Ref** +6, **Will** +8 with *unguent of timelessness*

Weakness vulnerability to fire

Speed 20 ft., fly 20 ft. (poor) (4 squares)

Melee swarm (3d6)

Space 10 ft.; **Reach** 0 ft.

Base Atk +1; **Grp** —

Atk Options mummy rot, parts

Special Actions distraction, fear, swarm form

Abilities Str 8, Dex 16, Con —, Int 12, Wis 14, Cha 20.

SQ hive mind, undead traits

Skills Concentration +15, Disguise +15, Knowledge (arcana) +9, Knowledge (religion) +4, Move Silently +7, Spellcraft +11

Distraction (Ex) Any living creature vulnerable to a swarm's damage that begins its turn with the swarm in its square is nauseated for 1 round; a Fortitude save, DC 18, negates the effect. Even with a successful save, spellcasting or concentrating on spells within the area of a swarm requires a Concentration check. Using skills requiring patience and concentration requires a DC 20 Concentration check. The save DC is Charisma-based.

Fear (Su) A creature damaged by a parts swarm must make a successful Will save, DC 18, or be frightened for 1d4 rounds. The save DC is Charisma-based.

Hive Mind (Ex) A swarm-shifter with this ability is immune to any spell or effect that targets a specific number of creatures with the exception of effects that command, control, turn, rebuke, bolster, or destroy undead specifically. A swarm-shifter in swarm form is affected by turn and rebuke attempts just like the base creature.

Parts (Ex) A parts swarm undead is a swarm made up of the body parts of the undead creature. This causes the swarm to deal an extra 1d6 points of damage with its swarm attack.

Swarm (Ex) Swarms deal automatic damage to any creature whose space they occupy at the end of their move, with no attack roll needed. Swarm attacks are not subject to a miss chance for concealment or cover. Swarms do not threaten creatures in their square, and do not make attacks of opportunity with their swarm attack.

DM MAP 1: THE TEMPLE OF PELOR

Ancient Temple of Pelor

- Legend**
- 1 – Spell Turret Trap
 - 2 – Minions of Iuz
 - 3 – Skeletons
 - 4 – Revived Fossil
 - 5 – Plague Walker
 - 6 – Necrosis Carnex
 - 7 – Herceptus the Unliving

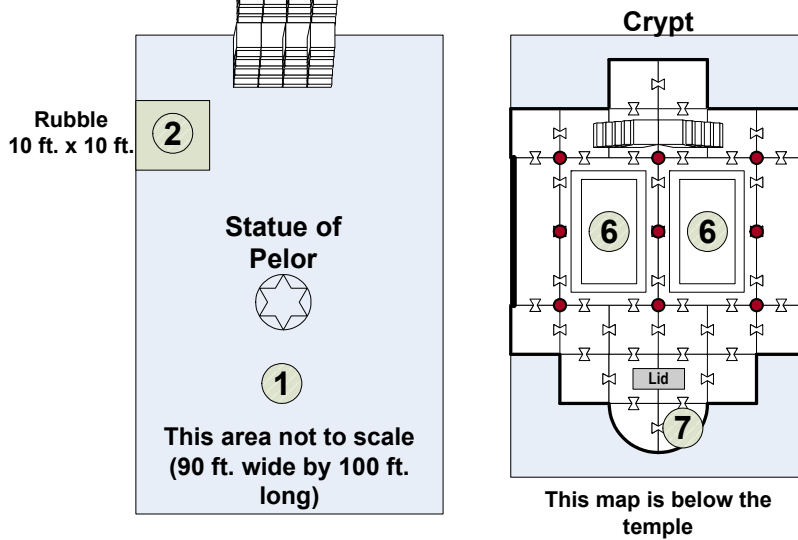
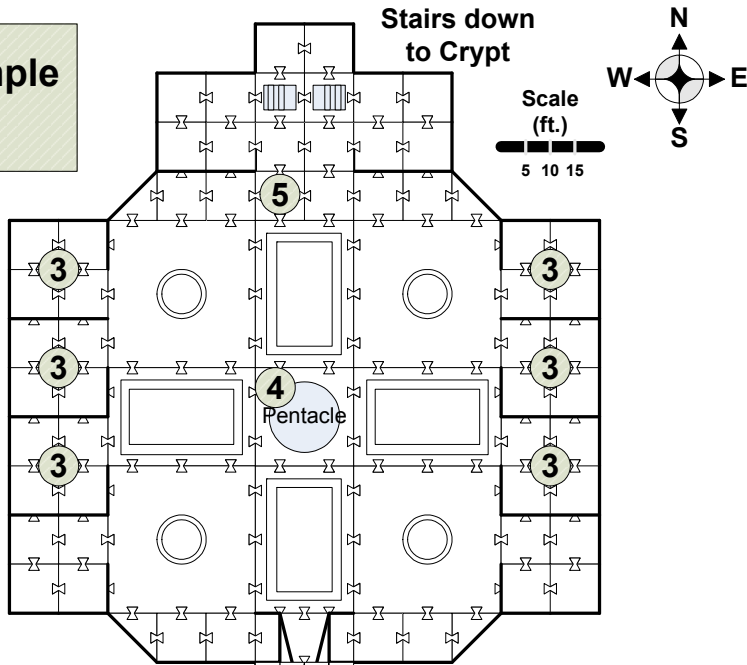

APPENDIX 2: NEW RULES ITEMS

DOMAINS

Domination

Granted Power: You gain Spell Focus (enchantment) as a bonus feat

Domination Domain Spells

- 1 **Command:** One subject obeys selected command for 1 round.
- 2 **Entrhall:** Captivates all within 100 ft. + 10 ft./level.
- 3 **Suggestion:** Compels subject to follow stated course of action.
- 4 **Dominate Person:** Controls humanoid telepathically.
- 5 **Command, Greater:** As *command*, but affects one subject/level.
- 6 **Geas/Quest:** As *lesser geas*, plus it affects any creature.
- 7 **Suggestion, Mass:** As *suggestion*, plus one subject/level.
- 8 **True Domination:** As *dominate person*, but save at -4.
- 9 **Monstrous Thrall:** As *true domination*, but permanent and affects any creature.

Source: *Spell Compendium* 273

Suffering (*Spell Compendium*)

Granted Power (Sp): You can use a pain touch once per day. Make a melee touch attack against a living creature, which bestows on that creature a -2 penalty to Strength and Dexterity for 1 minute on a successful attack. This ability does not affect creatures that have immunity to extra damage from critical hits.

Suffering Domain Spells

- 1 **Bane:** Enemies take -1 on attack rolls and saves against fear.
- 2 **Bear's Endurance:** Subject gains +4 to Con for 1 minute/level.
- 3 **Bestow Curse:** -6 to an ability score; -4 on attack rolls, saves, and checks; or 50% chance of losing each action.
- 4 **Enervation:** Subject gains 1d4 negative levels.
- 5 **Feeblemind:** Subject's Int and Cha drop to 1.
- 6 **Harm:** Deals 10 points/level damage to subject.
- 7 **Eyebite:** Subject becomes panicked, sickened, and comatose.
- 8 **Symbol of Pain:** Triggered rune wracks nearby creatures with pain.
- 9 **Horrid Wilting:** Deals 1d6/level damage within 30 ft.

Tyranny

Granted Power: Add +1 to the save DC of any enchantment (compulsion) spell you cast.

Tyranny Domain Spells

- 1 **Command:** One subject obeys selected command for 1 round.
- 2 **Entrhall:** Captivates all within 100 ft. + 10 ft./level.

- 3 **Discern Lies:** Reveals deliberate falsehoods.
- 4 **Fear:** Subjects within cone flee for 1 round/level.
- 5 **Command, Greater:** As *command*, but affects one subject/level.
- 6 **Geas/Quest:** As *lesser geas*, plus it affects any creature.
- 7 **Bigby's Grasping Hand:** Hand provides cover, pushes, or grapples.
- 8 **Charm Monster, Mass:** As *charm monster*, but all within 30 ft.
- 9 **Dominate Monster:** As *dominate person*, but any creature.

Source: *Spell Compendium* 281

FEATS

Fell Drain [Metamagic]

Living foes damaged by your spell also gain a negative level.

Benefit: You can alter a spell that deals damage to foes so that any living creature that is dealt damage also gains a negative level. If the subject has at least as many negative levels as Hit Dice, it dies. Assuming the subject survives, the negative level disappears (without requiring a Fortitude save) after a number of hours equal to your caster level (maximum 15). A fell draining spell uses up a spell slot two levels higher than the spell's actual level.

Source: *Libris Mortis*

Fell Weaken [Metamagic]

Foes damaged by your spell are also weakened.

Benefit: You can alter a spell that deals damage to foes so that any living creature that is dealt damage also takes a -4 penalty to Strength for 1 minute. Strength penalties from multiple spells enhanced by the Fell Weakening feat do not stack. A fell weakening spell uses up a spell slot one level higher than the spell's actual level.

Source: *Libris Mortis*

Improved Toughness

You are significantly tougher than normal.

Prerequisite: Base Fortitude save bonus +2.

Benefit: You gain a number of hit points equal to your current Hit Dice. Each time you get a HD (such as by gaining a level), you gain 1 additional hit point. If you lose a HD, (such as by losing a level) you lose 1 hit point permanently.

Special: A fighter may select Improved Toughness as one of his fighter's bonus feats.

Source: *Complete Warrior* 101.

Melee Weapon Mastery

You have mastered a wide range of weapons. Your training with one specific weapon now extends to other weapons of a similar sort.

Prerequisite: Proficiency with selected weapons,

Weapon Focus with selected weapon, Weapon Specialization with selected weapon, base attack bonus +8.

Benefit: When you select this feat, choose bludgeoning, piercing or slashing. You must have Weapon Focus and Weapon Specialization with a melee weapon that deals this type of damage. When using any melee weapon that has the damage type you select, you gain a +2 bonus on attack rolls and a +2 bonus on damage rolls.

Special: You can select this feat more than once, each time. Each time, you can select a new damage type.

A fighter may select Melee Weapon Mastery as one of his fighter bonus feats.

Source: *Player Handbook II* 81.

MAGIC ITEMS

Aroma of Curdled Death

This dark, viscous fluid is usually stored in a small stoppered bottle and applied like a perfume. One round after exposure to air, it creates and invisible cloud of poison gas in a 10-foot radius that lasts for 1 minute. The creature wearing the *aroma of curdled death* is protected from the cloud's effect, but all other exposed creatures with 3 Hit Dice or less die with no save. Creatures with 4 to 6 Hit Dice must succeed on a DC 17 Fortitude save each round they are exposed to the effect or die (taking 1d4 points of Constitution damage on a successful save), and creatures with 6 or more Hit Dice take 1d4 points of Constitution damage (Fortitude DC 17 half). The cloud moves as the creature does.

If the bottle is opened but the liquid within not immediately applied to a creature, the cloud of poison gas that forms spreads to fill only a 5-foot radius, centered on the opened bottle or the place the liquid was poured out. This cloud also lasts for 1 minute.

Moderate conjuration; CL 9th; Craft Wondrous Item, *cloudkill*, character must have 4 ranks in Craft (alchemy); Price 4,500 gp.

Source: *Complete Arcane*.

Skeletal runestaff

Price: 4,600 gp

Body Slot: - (Held)

Caster level: 12th

Aura: Strong (DC21) Necromancy and Abjuration

Activation: As spell used

Weight: 4lbs.

The skeletal runestaff allows you to cast any of the following spells by expending a prepared arcane spell or arcane spell slot of the same level or higher: *command undead* (3/day), *halt undead* (1/day) and *hide from undead* (3/day).

Prerequisites: Craft Staff, *command undead*, *halt undead*, *hide from undead*.

Cost to Create: 1,400gp, 112XP, 3 days.

A runestaff allows its wielder to use her arcane energy to generate magic effects. Typically, a runestaff has

anywhere from two to five spells. By expending a prepared arcane spell or arcane spell slot, the wielder can cast a spell of the same level or lower from the runestaff's list as long as that spell also appears on the wielder's spell list. The spell is treated exactly as if the wielder cast the spell herself, including caster level, save DC and any other effects related to the spell. Unless stated otherwise, in the runestaff's description each spell can be cast from a runestaff three times per day.

In order to use a runestaff, you must attune yourself to it as part of your preparation or readying of arcane spells. You can't attune yourself to more than one runestaff at a time; attuning yourself to a second runestaff breaks your previous attunement.

Activating a runestaff (that is, casting a spell from it) is almost like casting the spell yourself, including casting time and even provoking attacks of opportunity. You must supply any components or costs normally required by the spell cast from the runestaff, just as if you had cast it yourself.

If the spell has a verbal component, activating the runestaff requires you to perform that verbal component (and thus the spell can't be cast if you are incapable of speaking).

If the spell has a somatic component, you don't need to have an extra hand free, simply manipulating the staff can meet the requirements (though arcane spell failure chance still applies). If the spell has a material component or focus, you must supply it as part of the casting. If the spell has an XP component, you must pay it each time you use a runestaff to cast that spell.

If the spell has any other prerequisite required to cast it (such as an alignment or racial restriction), you must meet the prerequisite to cast the spell from a runestaff.

You can apply the effect of metamagic feats that you know to spells from a runestaff, but you must expend a spell whose level equals or exceeds the adjusted level of the affected spell.

A runestaff appears essentially identical to a normal staff of the same name, though it always bears arcane runes that reveal its name and the spells it holds to anyone who uses *read magic* or succeeds on a DC20 Spellcraft check.

Source: *Magic Item Compendium* pg. 223

SPELLS

Backbiter

Necromancy

Level: Sorcerer/wizard 1

Components: V, S, F

Casting Time: 1 standard action

Range: Close

Target: One weapon

Duration: 1 round/level or until discharged

Saving Throw: Will negates; see text

Spell Resistance: Yes (object)

The weapon you indicate during the spell's casting briefly shimmers with a black aura that disappears in an eyeblink.

You cast this spell on any melee weapon. The next time that weapon is used to make a melee attack, its shaft twists around so that the weapon strikes the wielder instead. The weapon hits automatically, and no attack roll is made.

The wielder gets no warning or knowledge of the spell's effect on his weapon, and although he makes the attack, the self-dealt damage can't be consciously reduced (though damage reduction applies) or changed to nonlethal damage. Once the weapon attacks its wielder (whether successfully or not), the spell is discharged.

Magic weapons targeted by this spell receive a Will save. An item in a creature's possession uses its own Will save bonus (2 + Caster Level required to enchant the weapon) or its wielder's bonus, whichever is higher.

Focus: A dagger.

Source: *Spell Compendium*.

Caltrops

Conjuration (Creation)

Level: Sorcerer/wizard 0

Components: V, S

Casting Time: 1 standard action

Range: Close

Area: See text

Duration: 1 round/level

Saving Throw: None

Spell Resistance: No

You speak the words and spread you palm, open, as if you were throwing jacks. Coppery sparks spring from your palm, filling the corridor with small four-pronged spikes.

A *caltrops* spell covers one 5-foot-by-5-foot square with caltrops. Every time a creature moves into an area covered by caltrops or spends a round fighting while standing in such an area, it might step on one. The caltrops make one attack roll (+0 melee) against the creature. For this attack, the target's shield and deflection bonuses do not count, nor does its armor bonus for armor worn. A target wearing shoes or other footwear gains a +2 armor bonus to Armor Class (which does count). If the caltrops succeed on the attack, the creature has stepped on one.

A successful attack by a caltrop deals 1 point of damage. If the target is Small, Medium, or Large, its land speed is reduced by one-half because of the injury. This movement penalty last for 24 hours, until the creature is successfully treated with a DC 15 Heal check, or until it receives at least 1 point of magical healing. A charging or running creature must immediately stop if it steps on a caltrop. Any creature moving at half speed or slower can pick its way through a bed of caltrops with no trouble.

The DM judges the effectiveness of caltrops against unusual opponents or opponents outside the size range given above. A giant centipede, for example, can scramble among caltrops with no chance of hurting itself, and a fire giant wearing thick, massive boots might be immune to their attacks.

For every two caster levels beyond 1st, you can affect an additional 5-foot-by-5-foot square, and the caltrops' attack bonus increases by 1. Thus, you affect two squares at 3rd level (+1 melee), three at 5th level (+2 melee), four at 7th level (+3 melee), and a maximum of five at 9th level or higher (+4 melee maximum).

Multiple *caltrops* spells (or mundane caltrops) occupying the same space have no additional effect.

Source: *Spell Compendium*.

Death Armor

Necromancy

Level: Sorcerer/wizard 2

Components: V, S, M, F

Casting Time: 1 standard action

Range: Personal

Target: You

Duration: 1 round/level

You smear yourself with white paste, drawing a skull on your bare flesh. Immediately, a wreath of black flames crackles to life around you.

The black flames created by this spell injure creatures that contact them. Any creature striking you with its body or handheld weapon takes 1d4 points of damage +1 per two caster levels (maximum +10). If the creature has spell resistance, it applies to the damage. Weapons with reach, such as longswords, do not endanger their users this way.

Material Component: Paste made from ground bones.

Focus: An onyx worth 50 gp.

Source: *Spell Compendium*.

Ghostharp

Divination

Level: Bard 0

Components: V, S

Casting Time: 1 minute

Range: Touch

Target: Object touched

Duration: 5 minutes/level (D)

Saving Throw: None

Spell Resistance: No

You place the coin on the table, touch it, and whisper the words of the spell. Softly the coin begins to replay the music of the previous night's performance.

You prepare an object that records and replays a song previously played or sung in its vicinity. When cast, the spell searches a radius of 50 feet for the lingering notes of a tune played there within the last day. It records these notes and reverberations. At your verbal command, "Play", the ghostharp replays the music. The tune repeats until you command it to stop, or until its duration comes to an end. The ghostharp does not record conversations. Its imperfect replay can't reproduce bardic music or other magical effects, nor can it cast spells.

Source: *Spell Compendium* 104

Herald's Call

Enchantment (Compulsion)

Level: Bard 1

Components: V, S

Casting Time: 1 swift action

Range: 20 ft.

Area: 20-ft.-radius burst centered on you.

Duration: 1 round

Saving Throw: Will negates

Spell Resistance: Yes

By placing your hand to your mouth and calling out, you gain the attention of creatures around you. For a moment, all eyes snap to you. Some creatures seem reluctant or unable to pull their eyes away.

Any creature with 5 Hit Dice or less is slowed (PH 280) for 1 round. Creatures beyond the radius of the burst might hear the shout, but they are not slowed. An affected creature under the effect of a *haste* spell has the *haste* spell suppressed (not dispelled) for one round.

Source: *Spell Compendium* 113

Lesser Vigor

Conjuration (Healing)

Level: Cleric 3, druid 3

Components: V, S

Casting Time: 1 standard action

Range: Touch

Target: Living creature touched

Duration: 10 rounds + 1 round/level (max 15 rounds)

Saving Throw: Will negates (harmless)

Spell Resistance: Yes (harmless)

The sounds of battle ring in your ears as you lay hands on your fallen comrade. You can spare neither time nor magic to do more right now, but the blood flow slows to a trickle and his breathing becomes less labored, even as you are called to the aid of another.

The subject gains fast healing 1, enabling it to heal 1 hit point per round until the spell ends and automatically becoming stabilized if it begins dying from hit point loss during that time. *Lesser vigor* does not restore hit points lost from starvation, thirst, or suffocation, nor does it allow a creature to regrow or attach lost body parts.

The effects of multiple *vigor* spells do not stack; only the highest-level effect applies.

Source: *Spell Compendium* 229

Lively Step

Transmutation

Level: Bard 2, sorcerer/wizard 2

Components: V, S, F

Casting Time: 1 standard action

Range: 30 ft.

Area: 30 ft.-radius emanation centered on you.

Duration: Up to 12 hours

Saving Throw: Will negates (harmless)

Spell Resistance: Yes (harmless)

Beating a small drum and singing a marching tune, you exhort your allies to struggle on.

Once you cast this spell, the speed of you and all allies within 30 feet of you increases by 10 feet.

You and other affected creatures can only benefit from this spell by refraining from taking any actions other than move actions. When one of the affected creatures takes any other kind of action, this spell ends.

Focus: A small drum

Source: *Spell Compendium* 133

Minor Disguise

Transmutation

Level: Bard 0

Components: V, S

Casting Time: 1 standard action

Range: Personal

Target: You

Duration: 1 hour

Your fingertips glow blue, and you add a few details to enhance your disguise.

You use magic to make minor, cosmetic changes in your appearance. The spell does not change the actual structure of either your features or body. It can add color to hair, paint wrinkles upon your face, give you a scar, or darken your teeth. This spell gives you a +2 competence bonus on the next Disguise check you make during its duration.

Source: *Spell Compendium* 142

Slash Tongue

Transmutation [Evil]

Level: Cleric 0, sorcerer/wizard 0

Components: V, S

Casting Time: 1 standard action

Range: Close

Target: One living creature with a tongue

Duration: 1 round

Saving Throw: Fortitude negates

Spell Resistance: Yes

The subject's tongue gets a thin cut. The subject takes 1 point of damage and takes a -1 penalty on attack rolls, saving throws, skill checks, and ability checks on the following round due to the annoying pain.

Source: *Book of Vile Darkness*

Sonic Snap

Evocation [Sonic]

Level: Sorcerer/wizard 0

Components: V, S

Casting Time: 1 standard action

Range: Close

Target: One creature or object
Duration: Instantaneous
Saving Throw: Will partial
Spell Resistance: Yes

You bark the last word of the spell, and that word takes life, streaking toward your target and exploding in a shout.

You create a brief but loud noise adjacent to the target. The subject takes 1 point of sonic damage and must succeed on a Will saving throw or be deafened for 1 round. This spell has no effect if cast into the area of a silence spell.

Source: *Spell Compendium*.

Spirit Worm

Necromancy
Level: Sorcerer/wizard 1
Components: V, S, M
Casting Time: 1 standard action
Range: Touch
Target: Living creature touched
Duration: 1 round/level, up to 5 round, see text
Saving Throw: Fortitude negates; see text
Spell Resistance: Yes

You press the bit of blackened bone against your foe and intone the spell. The bone vanishes, leaving a mottled bruise where it touched.

You create a lingering decay in the spirit and body of the target. If the target fails its saving throw, it takes 1 point of Constitution damage each round while the spell lasts (maximum 5 points). The victim can attempt a Fortitude saving throw each round, and success negates the Constitution damage for that round and ends the spell.

Material Component: A piece of fire-blackened ivory or bone carved in the shape of a segmented worm.

Source: *Spell Compendium*.

Stone Bones

Transmutation
Level: Cleric 2, sorcerer/wizard 2
Components: V, S, F
Casting Time: 1 standard action
Range: Touch
Target: Corporeal undead creature
Duration: 10 minutes/level
Saving Throw: Will negates (harmless)
Spell Resistance: Yes (harmless)

A brief flash engulfs your ally, and through his flesh you can see his skeleton. The skeleton glows a foggy gray for a moment thickening with eldritch power, then all is as it was before.

You cause the skeleton of the target corporeal undead to become thicker and as strong as stone. This gives the subject a +3 enhancement bonus to its existing natural armor.

Arcane Focus: A miniature skull carved of granite.

Summon Undead I

Conjuration (Summoning) [Evil]
Level: Blackguard 1, cleric 1, sorcerer/wizard 1
Components: V, S, F/DF
Casting Time: 1 round
Range: Close
Effect: One summoned creature
Duration: 1 round/level
Saving Throw: None
Spell Resistance: No

This spell functions like *summon monster I*, except that you summon an undead creature.

Summon undead I conjures one of the creatures from the 1st-level list on the Summon Undead table. You choose which creature to summon, and you can change that choice each time you cast the spell. Summoned undead do not count toward the total Hit Dice of undead that you can control with *animate dead* or the other command undead abilities.

Focus: A tiny bag, a small (not lit) candle, and a craved bone from any humanoid.

Source: *Spell Compendium*.

Summon Undead II

Conjuration (Summoning) [Evil]
Level: Blackguard 2, cleric 2, sorcerer/wizard 2
Effect: One or more summoned creatures, no two of which can be more than 30 ft. apart

This spell functions like *summon undead I*, except that you can summon one undead from the 2nd-level list or two undead of the same kind from the 1st-level list.

Summon Undead

1st Level	2nd Level
Skeleton, Medium	Skeleton, Large
Zombie, Small	Zombie, Medium

Serene Visage

Illusion (Glamer)
Level: Bard 1, sorcerer/wizard 1
Components: V, S
Casting Time: 1 standard action
Range: Personal
Target: You
Duration: 1 minute/level

By casting this spell, you imbue yourself with an ephemeral quality that induces others to trust what you say.

Simple illusions aid your attempts to be persuasive. You gain an insight bonus equal to one-half your caster level (maximum +10) on Bluff checks.

Source: *Spell Compendium* 182

Songbird

Transmutation

Level: Bard 0

Components: V, S

Casting Time: 1 round

Range: Personal

Target: You

Duration: Performance +1 hour or until discharged; see text

You intone this simple spell and your control over your voice improves, your unruly hair straightens, and your flesh radiates a healthy glow. You're ready for showtime.

You acquire an even greater charisma when you perform. Anyone who hears or views your performance becomes favorably inclined toward you. This spell grants you a +1 competence bonus on your next Charisma-based check involving any one person who saw the performance. This effect lasts for the duration of your performance and up to 1 hour immediately following. You must begin the performance within 1 hour of casting the spell for it to have any effect.

Source: *Spell Compendium* 195

Stabilize

Conjuration [Healing]

Level: Paladin 2, cleric 2

Components: V, S, DF

Casting Time: 1 swift action

Area: 50-ft.-radius burst centered on you

Duration: Instantaneous

Saving Throw: Will negates (harmless)

Spell Resistance: Yes (harmless)

Filled with compassion and concern, you draw upon your deity's power. A burst of golden energy springs forth, spreading from you. Those still alive around you seem less bloody and in less pain.

This spell, designed to work on the battlefield, allows you to stabilize the dying all around you. A burst of positive energy spreads out from you, healing 1 point of damage to all living creatures in the affected area, whether allied or not. This spells deals 1 point of damage to all undead

creatures, which are allowed a Will saving throw to negate the effect.

Source: *Spell Compendium* 104

Undersong

Transmutation

Level: Bard 1

Components: V

Casting Time: 1 standard action

Range: Personal

Target: You

Duration: 10 minutes/level

When you cast this spell, a familiar and soothing song wells up in your mind.

This spell brings to your mind a song that helps you retain your concentration. The song does not distract you from any task at hand—on the contrary, by humming along to the tune, you can focus your mind with ease. As long as this spell is in effect, you can make a Perform check in place of a Concentration check.

Source: *Spell Compendium* 104

Veil of Shadow

Evocation [Darkness]

Level: Assassin 2, blackguard 2, cleric 2, sorcerer/wizard 2

Components: V, S

Casting Time: 1 standard action

Range: Personal

Target: You

Duration: 1 minute/level

You speak the words of this spell, and tendrils of purple darkness rise from the ground, surrounding you and concealing you from your foes.

Swirling wisps of darkness obscure your form, granting you concealment. The 20% miss chance is in effect even if the attacker has darkvision.

This spell effect is dispelled in daylight or in the area of a light spell of 3rd level or higher.

Source: *Spell Compendium* 228

DM MAP 1: THE FREE CITY AND THE RUINS

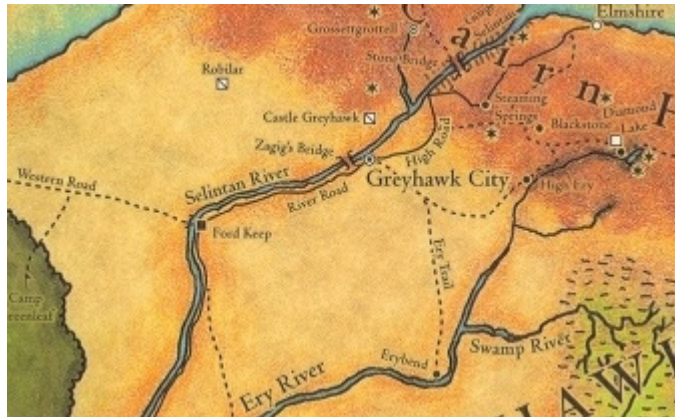

DM MAP 2: THE RUINS

